

BT-CSIV2

# Intravenous Injection Training Arm Model

## USER GUIDE

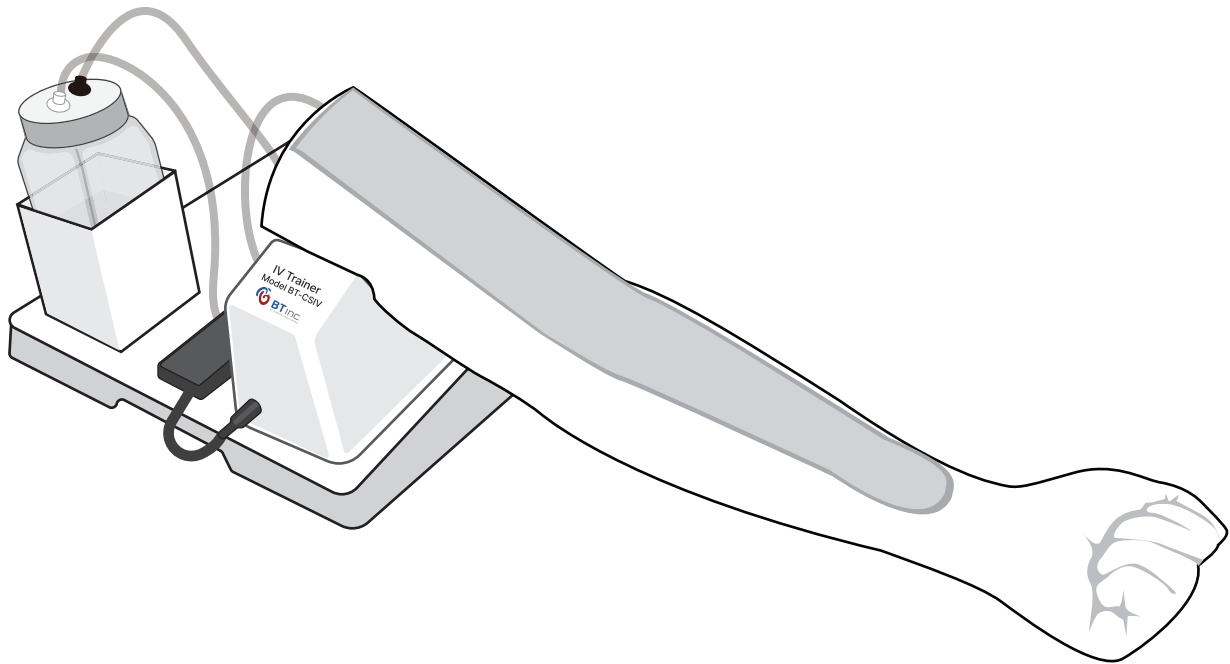

User Guide



## Product Information

Product Name	Intravenous Injection Training Arm Model
Model Name	BT-CSIV2
Manufacturer	BT Inc.
Country of Origin	Republic of Korea
Certification	

(Contains FCC ID : S7A-IW05)

## Product Specification

Dimensions	580 X 120 X 80mm
Weight	5.5kg
Power Converter	Input AC100-240~, 50/60Hz, 0.4A Output DC 12V, 1.5A
Battery	8EA of LR6 (AA, 1.5V)

## Customer Service

Website	<a href="http://www.btinc.co.kr">www.btinc.co.kr</a>
Address	A-313, Samsung Techno-valley, 140, Tongil-ro, Deogyang-Gu, Goyang-Si, Gyeonggi-do, 10594, Republic of Korea
Telephone	+82-2-2038-2903
E-mail	<a href="mailto:bt@btinc.co.kr">bt@btinc.co.kr</a>



## Cautions for battery disposal

- \* Please follow the regulations of corresponding area for the disposal of used batteries.

# Cautions

Please read it carefully to ensure correct usage and user's safety through understanding of the product.

- ① Use only components provided or approved by BT Inc.
- ② Do not use the product for other purposes described in this manual.
- ③ If you disassemble or modify the product without any permission by BT Inc, you cannot get the warranty. Also, making imitated or altered products for commercial purposes are prohibited by law.
- ④ During the usage, please contact us after any electricity power off when the product is overheated or smelled something burning
- ⑤ Keep the product away from water or moisture. If the product gets wet, do not turn it on.
- ⑥ Do not use the product near strong magnetic fields or high voltage power lines.  
The product might malfunction due to the electromagnetic waves.
- ⑦ Do not use the product under a weather of lightning. It can cause the product malfunction and increases the risk of electric shock
- ⑧ Do not use the product with temperatures below 0°C or above 40°C  
(Operation temperature : 0°C ~ 40°C, Storage temperature : -10°C ~ 50°C)
- ⑨ Do not keep the product near hot places such as heaters. Deterioration of product or internal damage might occur
- ⑩ Never clean the product with chemical substances such as solvent, benzene or thinner, as these may Cause ignition or cause the surface deterioration.
- ⑪ BT Inc. can change or adjust the product specification without any notice in order to improve the product.

# 구성품

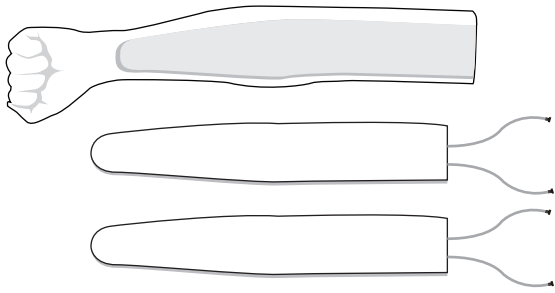

Arm manikin & Skin pad(2ea)

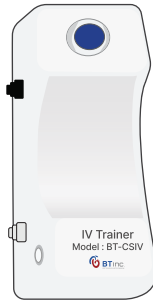

Blood circulation system

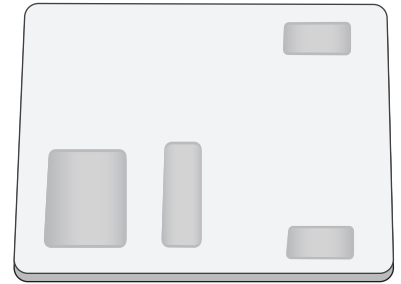

Stand



Blood supply bottle



Connection tube

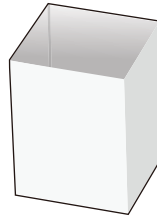

Bottle stand



Simulated blood

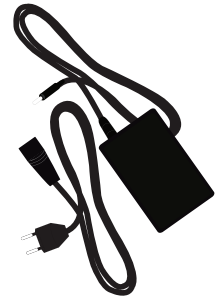

Power adapter

\* etc. - Storage bag, Battery holder

## Consumables

- Skin pad
- Simulated blood
- Connection tube

## Recommended Clinical Supply Sizes

Needle	3cc~5cc, 23G
Angio catheter	22G~24G

- The following clinical supply sizes are recommended for use with our IV arm models.
- Other sizes may cause damage to the products.
- Lifetime of the consumables may differ depending on the skill level of the users.

# Installation

## (1) Parts name

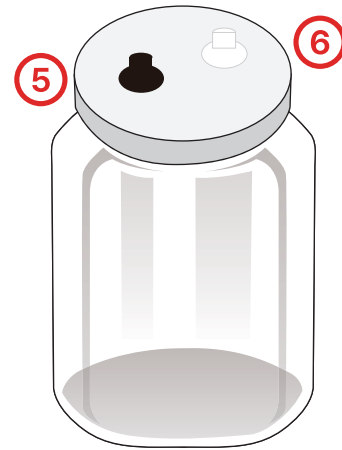

- ① Timer switch
- ② Rapid blood circulation switch
- ③ Blood OUT connector (Black)
- ④ Blood IN connector (White)
- ⑤ Blood supply bottle OUT connector (Black)
- ⑥ Blood supply bottle IN connector (White)

## (2) Installation of product on the stand

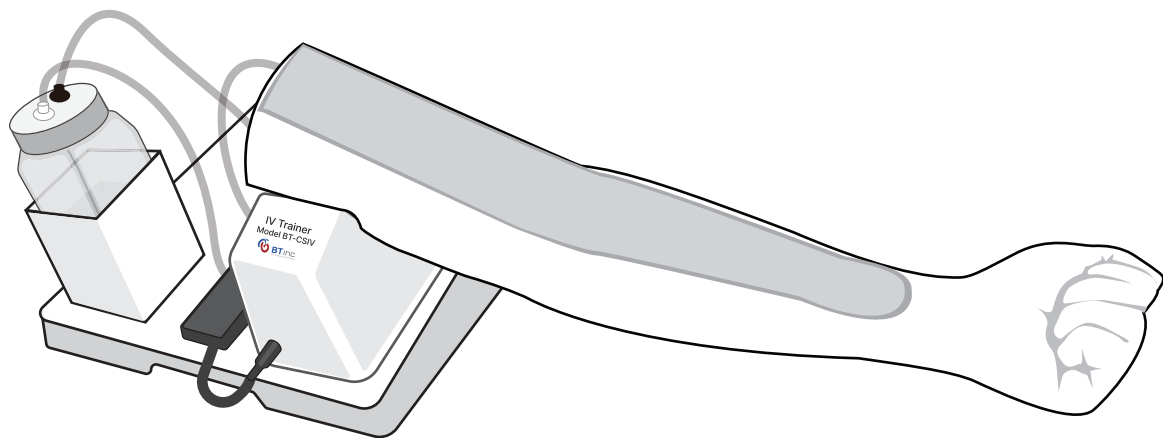

- Please arrange the product as the picture above.
- Drop a few drops of simulated blood in a blood supply bottle with some water and shake it.

## (3) Installation of Skin Pad

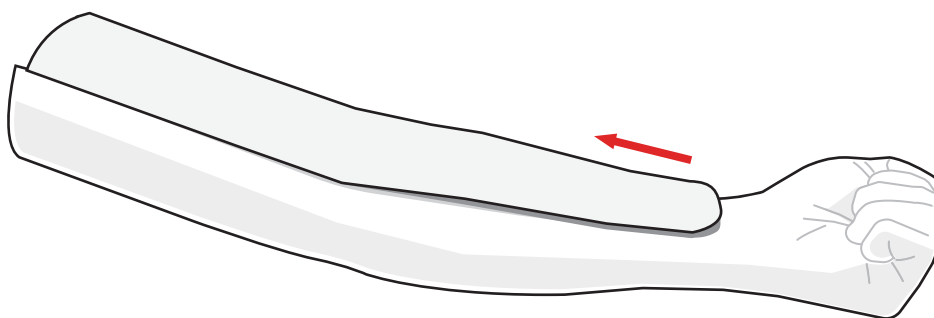

- Take the separate paper on the back of the Skin pad off.
- Install the skin pad to the arm model from the back of the hand to the end.
- If the skin pad doesn't go in the arm hand well, please apply the body lotion lightly to the edge of the groove.

#### (4) How to connect the tubes

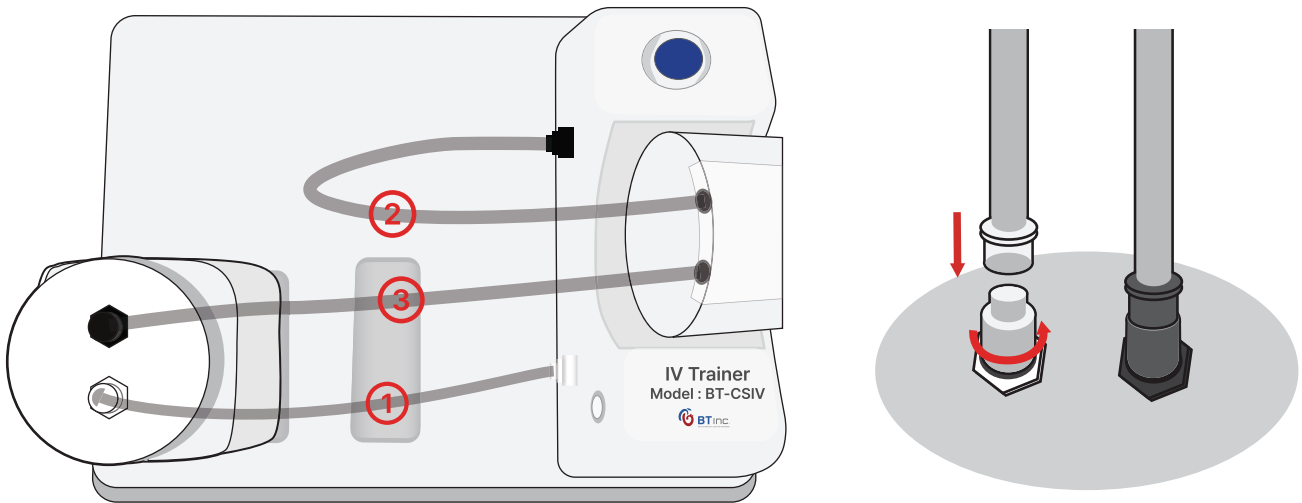

Referring to the picture above,

- ① Connect the tube with white connectors on both ends to the white IN connector on the blood circulation system and blood supply bottle.
- ② Connect a tube with black connectors on both ends to the black OUT connector on the blood circulation system and the skin pad.
- ③ Connect another tube with black connectors on both ends to the black OUT connector on the blood supply bottle and the skin pad.
- ④ To connect the connectors, turn the connectors clockwise until you hear click sound.

#### (5) Power connection

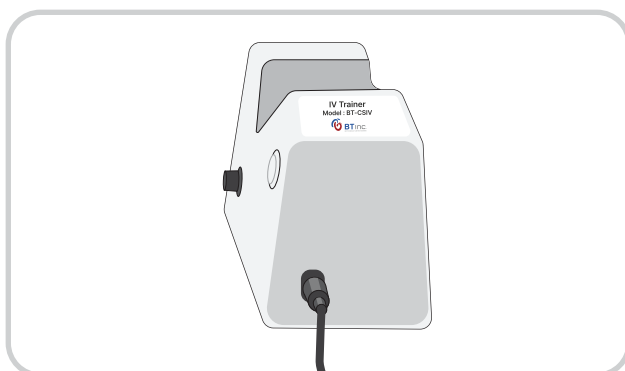

<External Power Connection>

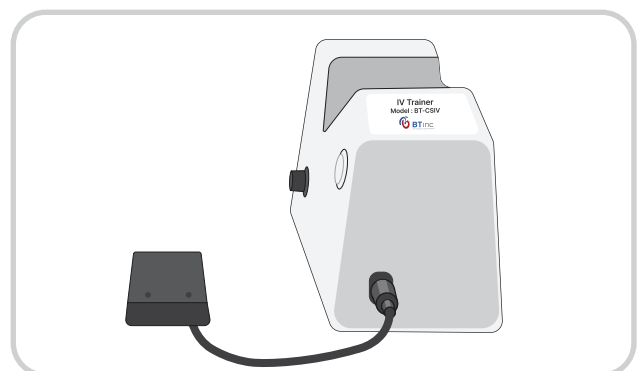

<Battery Connection>

- The product can be powered by AC adapter or battery

# Functions

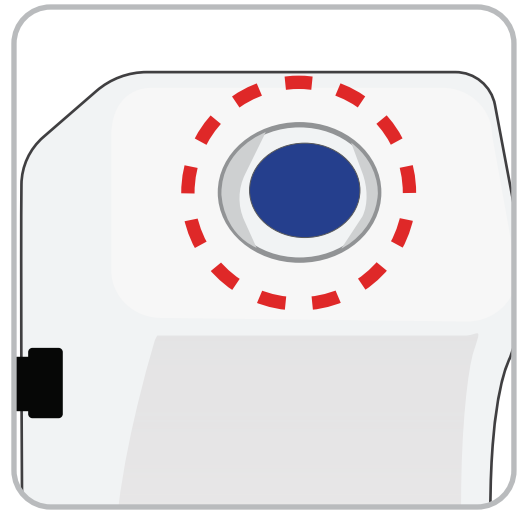

- The beep will sound when the power supply is connected.
- Press and hold the rapid blood circulation button to fill the vein with the simulated blood.
- Press the timer button to run the simulator.

Please refer to the table at below for the running time of the circulation pump according to the number of times the timer button is pressed.

No. of counts for pressing timer switch	Total Operating time(min)	Buzzer Sound	Remark
1	5	1	beep
2	10	2	beep-beep
3	15	3	beep-beep-beep
4	20	4	beep-beep-beep-beep
5	25	5	beep-beep-beep-beep-beep
6	30	6	beep-beep-beep-beep-beep-beep
7	Automatic Stop	3	beep-beep-----beep

- To stop the circulation pump while it's running, press the timer button and hold for 3 seconds.
- All beep sounds meaning the stop of the circulation pump will sound 3 times, "beep-beep-beep".
- While using batteries, the blood circulation system is being stopped with the 5 times of beep sound when batteries are low.



# Cleaning and Storage

## (1) How to clean the model

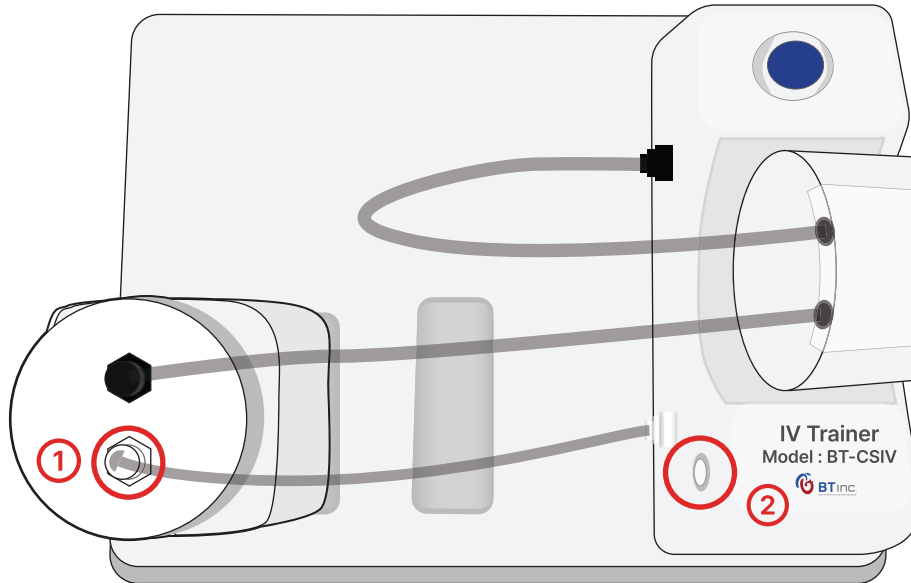

- ① Disconnect the tube with white connector from the white IN connector on the blood supply bottle.
- ② Drain the simulated blood from the vein by pressing the rapid blood circulation button, empty the blood supply bottle and refill it with clean water.  
Simulated blood can be used multiple times in case you store it in the empty bottle.
- ③ Reconnect the tube with white connector to the white IN connector on the blood supply bottle and flush with clean water.
- ④ Repeat ①~③ until you confirm clean water.
- ⑤ Empty the blood supply bottle, disconnect connectors and wipe the parts with a tissue or cloth.
- ⑥ When the cleaning is done, store it in the storage case.

## (2) How to maintain the arm model

- Clean the model with the wet cloth.
- In case the additional maintenance is needed, clean it with an alcohol swap or a soft cloth soaked in alcohol.
- Wipe it out with a clean dried cloth and let it dry.

## **FAQ**

### **(1) The blood circulation system is not running.**

- The beep will sound when the power supply is connected.
- If you didn't hear the beep sound, please check the power supply is firmly connected.
- Please change the batteries, the power of batteries may low.
- If the issue remains after this solution, please contact to the local distributor or BT.

### **(2) The blood circulation system stops running while using it.**

- When it was stopped because of the timer, the beep sound would occur. (beep, beep-----, beep)
- In it stopped running without beep sound, please check the power supply is firmly connected.
- Please change the batteries, it could be stopped when the batteries are low.
- If the issue remains after this solution, please contact to the local distributor or BT.

### **(3) The number of times the timer button is pressed and the number of sounds of timer are different.**

- Please turn off the blood circulation system and retry at 1 second intervals.
- The timer may be malfunctioning when it's being pressed too fast.

BT-CSIV2

# Intravenous Injection Training Arm Model

A-313, Samsung Techno-valley, 140, Tongil-ro  
Deogyang-gu, Goyang-si, Gyeonggi-do, 10594, Republic of Korea

Homepage: [www.btinc.co.kr](http://www.btinc.co.kr) / E-mail: [bt@btinc.co.kr](mailto:bt@btinc.co.kr)  
Tel: +82-2-2038-2903, +82-51-903-1144 / Fax: +82 303-3130-0607

Copyright(c) BT Inc. All rights reserved.