

BT-SEEM-Air

CPR&Airway Management Training Model

USER GUIDE

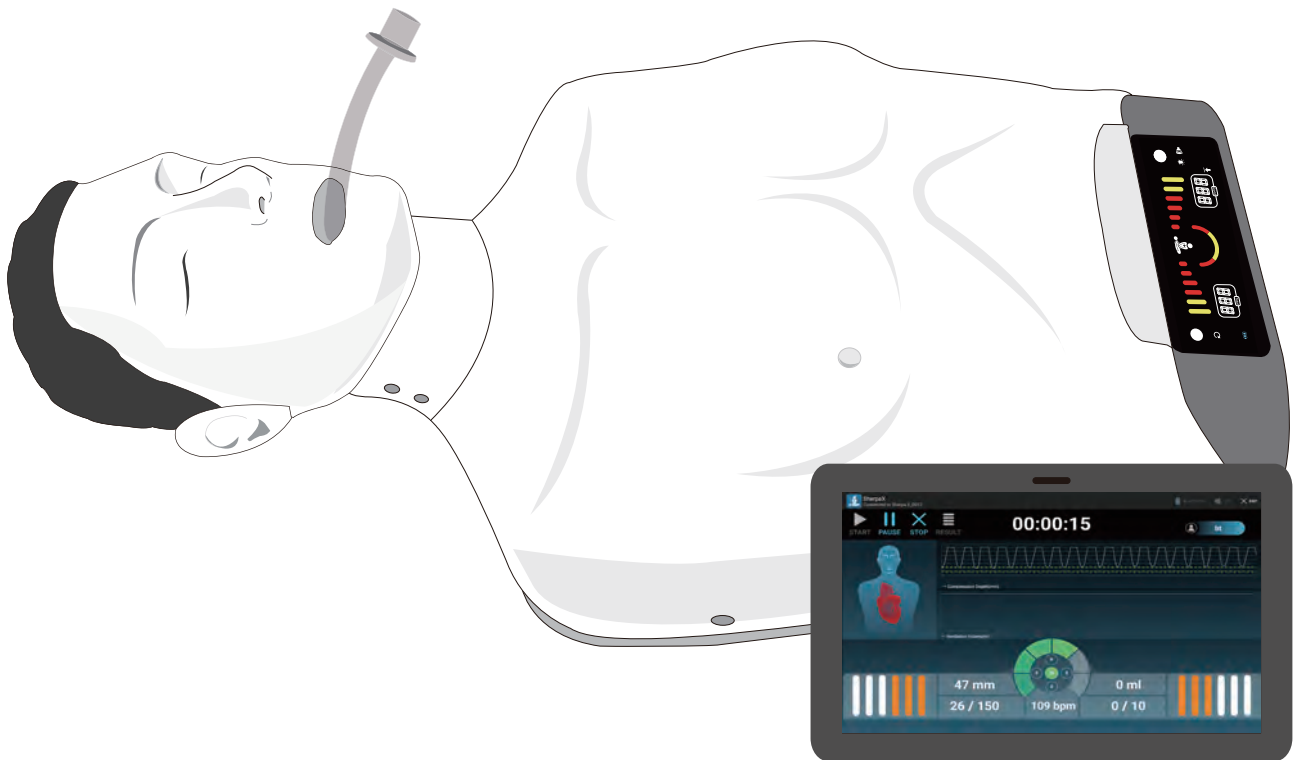

User Guide



Product Information

Product Name	CPR&Airway Management Training Model
Model Name	BT-SEEM-Air
Manufacturer	BT Inc.
Country of Origin	Republic of Korea
Certification	

(Contains FCC ID : S7A-IW05)

Product Specification

Dimensions	330 X 670 X 210mm
Weight	6.4 kg
Power Converter	Input AC100-240~, 50/60Hz, 0.4A Output DC 12V, 1.5A
Battery	6EA of LR14 (C, 1.5V)

Customer Service

Website	www.btinc.co.kr
Address	A-313, Samsung Techno-valley, 140, Tongil-ro, Deogyang-Gu, Goyang-Si, Gyeonggi-do, 10594, Republic of Korea
Telephone	+82-2-2038-2903
E-mail	bt@btinc.co.kr



Cautions for battery disposal

- * Please follow the regulations of corresponding area for the disposal of used batteries.

Cautions

Please read it carefully to ensure correct usage and user's safety through understanding of the product.

- ① Use only components provided or approved by BT Inc.
- ② Do not use the product for other purposes described in this manual.
- ③ If you disassemble or modify the product without any permission by BT Inc, you cannot get the warranty. Also, making imitated or altered products for commercial purposes are prohibited by law.
- ④ During the usage, please contact us after any electricity power off when the product is overheated or smelled something burning
- ⑤ Keep the product away from water or moisture. If the product gets wet, do not turn it on.
- ⑥ Do not use the product near strong magnetic fields or high voltage power lines.
The product might malfunction due to the electromagnetic waves.
- ⑦ Do not use the product under a weather of lightning. It can cause the product malfunction and increases the risk of electric shock
- ⑧ Do not use the product with temperatures below 0°C or above 40°C
(Operation temperature : 0°C ~ 40°C, Storage temperature : -10°C ~ 50°C)
- ⑨ Do not keep the product near hot places such as heaters. Deterioration of product or internal damage might occur
- ⑩ Never clean the product with chemical substances such as solvent, benzene or thinner, as these may Cause ignition or cause the surface deterioration.
- ⑪ BT Inc. can change or adjust the product specification without any notice in order to improve the product.

Components

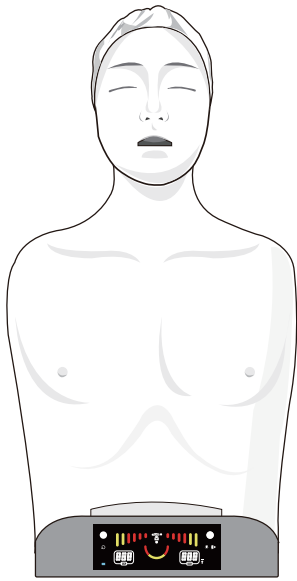

Adult Torso Manikin

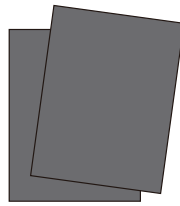

Magnetic sticker for AED trainer pads



Lubricant for intubation

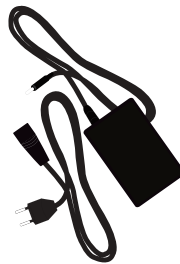

Power Adaptor

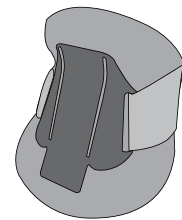

Cervical collar

* etc. - Storage bag, USB Cable(Power bank connector)

* Option (sold separately) - Tablet, Power bank

Consumables

- Magnetic Sticker for AED trainer pads
- Skins(Face, Body)
- Lung Bag
- Lubricant for intubation
- Airway for replacement

Recommended Clinical Supply Sizes

ETT	I.D. 7.0~8.0mm
I-gel / LMA	#3, #4
Combitube	37Fr
OPA	80mm(Green)
NPA	6~7 (24~28Fr)

- The following clinical supply sizes are recommended for use with our CPR & Airway management Training Model.
- Other sizes may cause damage to the products.
- Lifetime of the consumables may differ depending on the skill level of the users.

Features

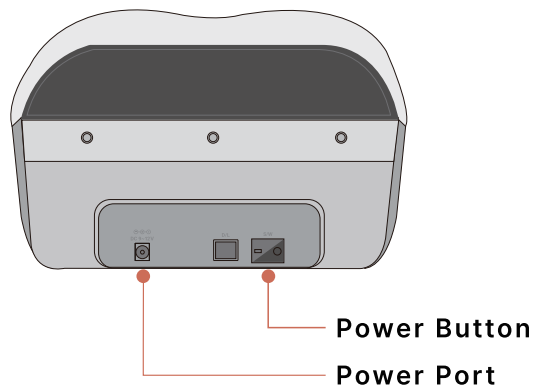
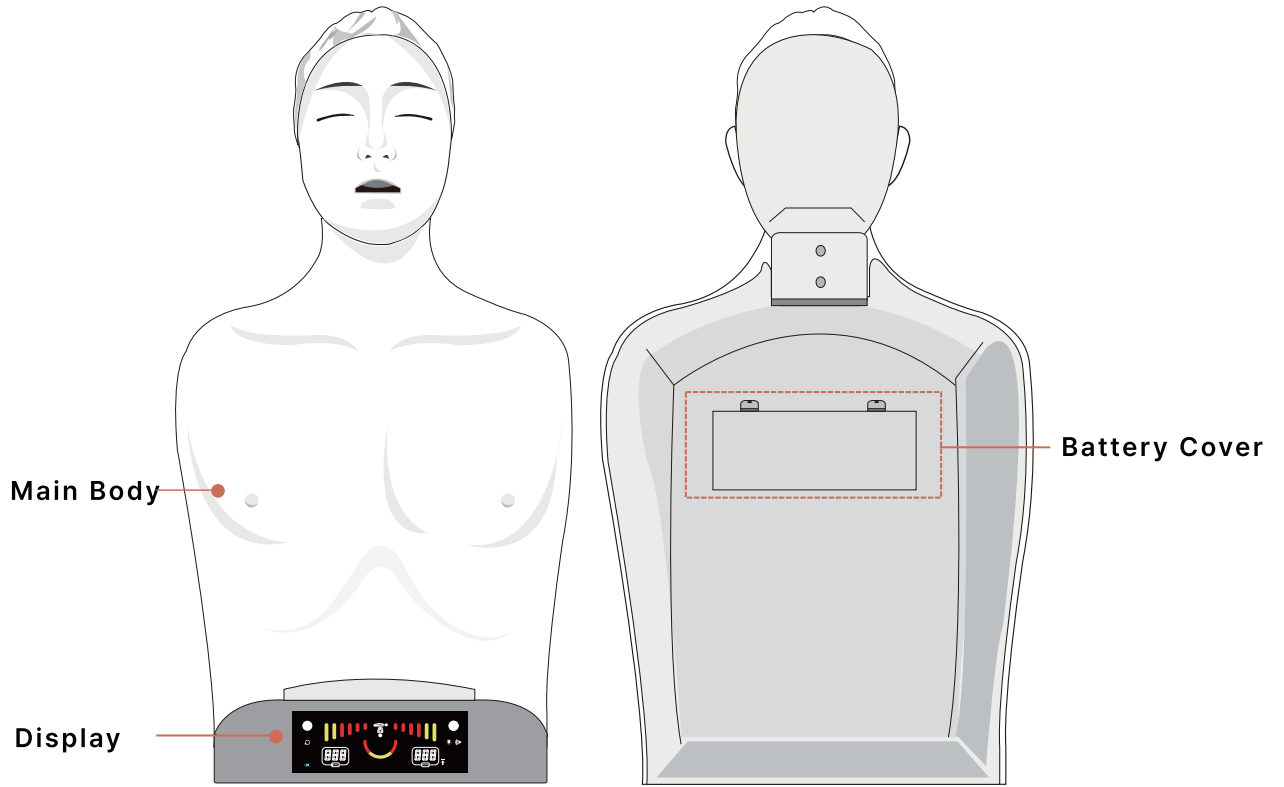

Power connections

(1) Battery power supply

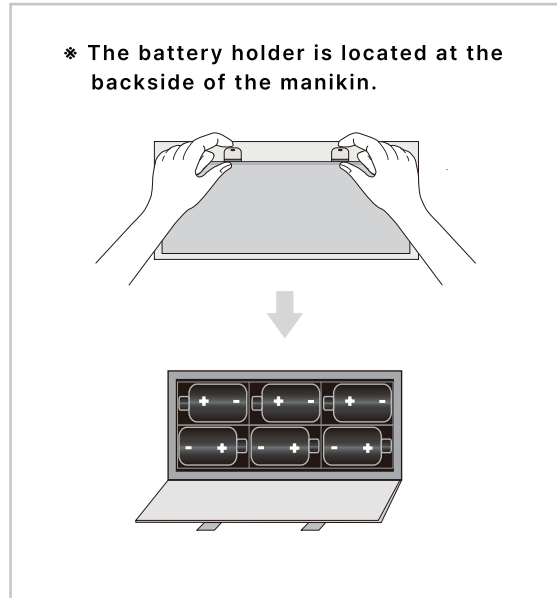
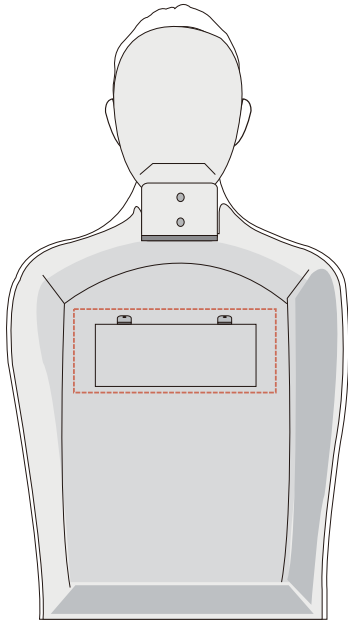

- ① Open the battery cover at the backside of the manikin by pressing the stoppers with both index fingers.
- ② Insert 6 batteries into the battery holder with correct polarities.
- ③ Use LR14(C-type, 1.5V) standard batteries only.

(2) External AC power supply

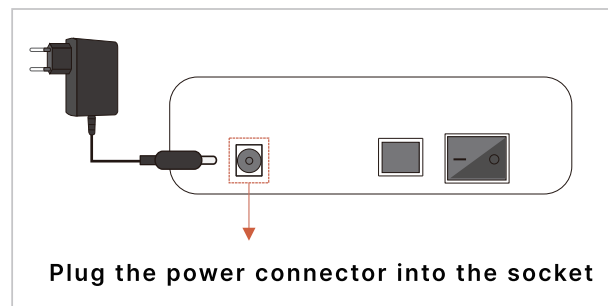
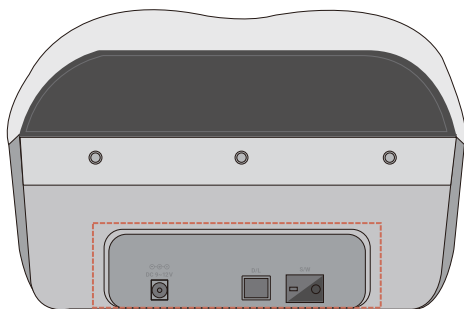

- Use only the power converter supplied by manufacturer.
- In case of using a power bank, please use an included USB cable.
- Some models of power banks may not be compatible with product.

Use the magnetic papers

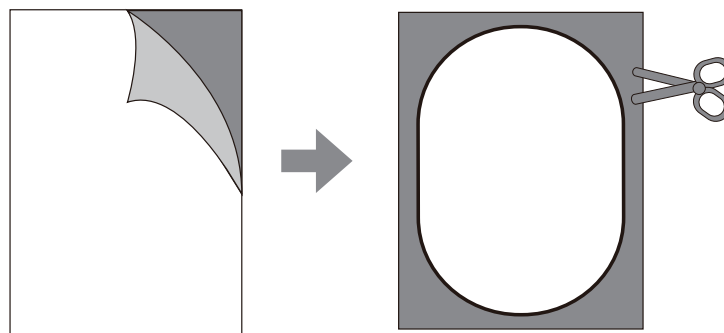
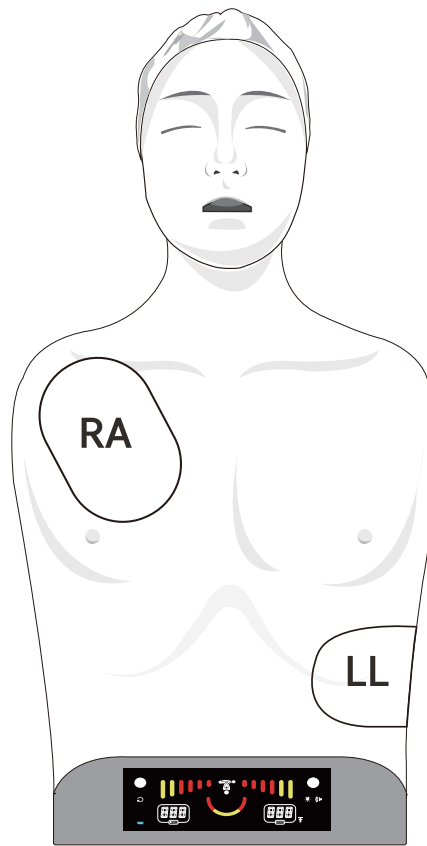

- ① Prepare the AED trainer.
- ② Remove the release liner from the provided magnetic stickers.
- ③ Put magnetic stickers on AED trainer's pads.
- ④ Cut the outer edge of magnetic stickers
- ⑤ AED trainer's pad will be attached to the manikin due to embedded magnets inside of the manikin.

- Adhesion may vary depending on the condition and location of pads.

Functions

(1) Chest compression

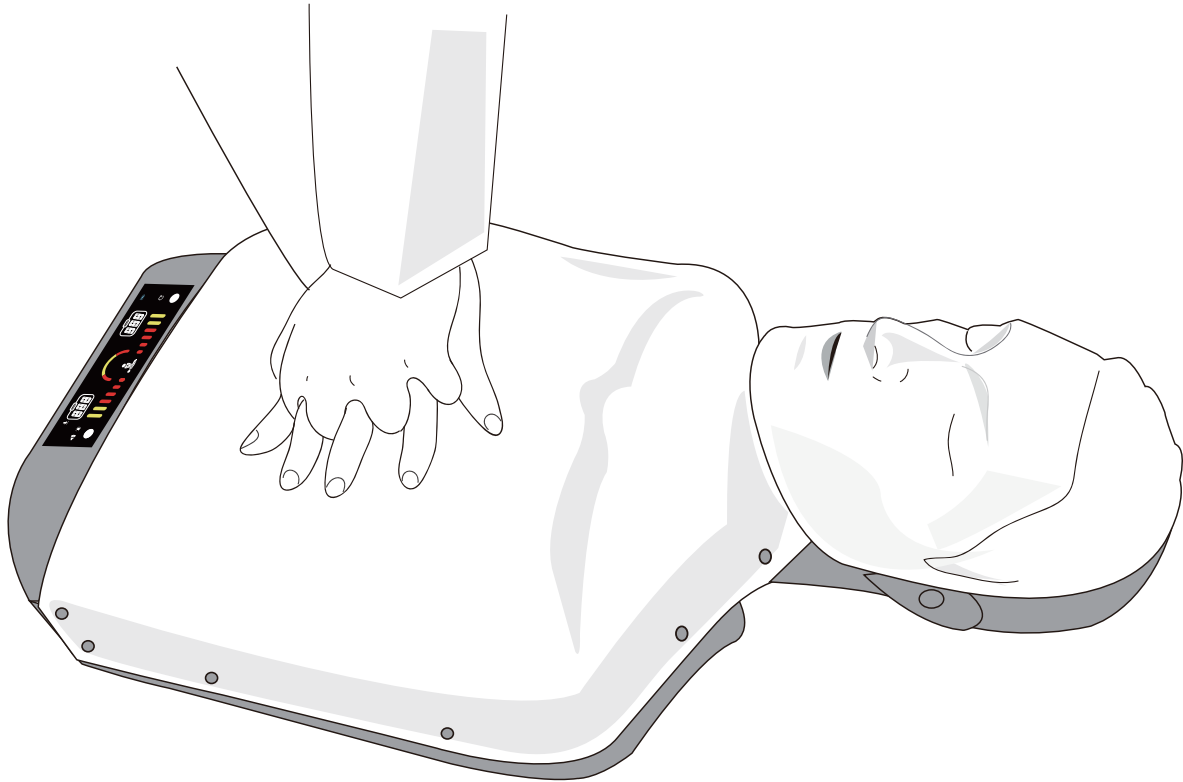

- ① Connect the power adaptor or insert fully charged batteries, then press and release the power button.
- ② When the display is on, select the display option and start the chest compression.
- ③ Compression depth, compression rate, total compression counts and correct compression counts are displayed on the LED panel.

(2) Opening airway

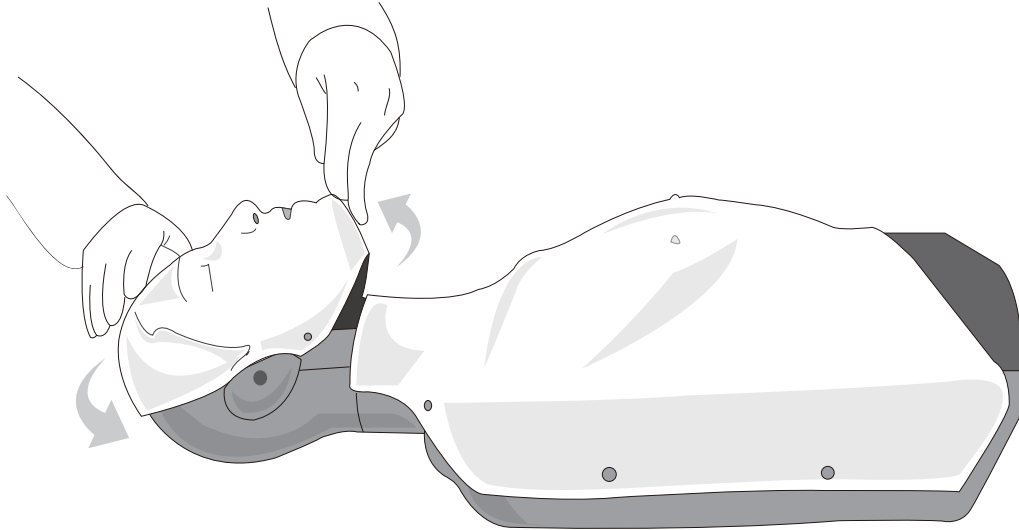

(3) Ventilation

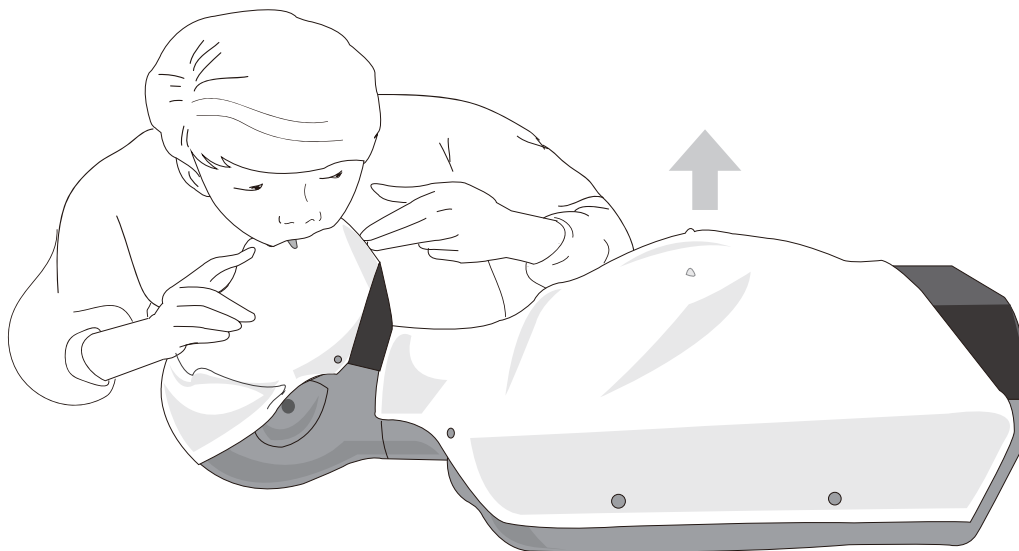

- ① Tilt the head back to open the airway.
- ② Pinch the nose of the manikin and conduct mouth to mouth resuscitation.
(Pay attention to the chest rising.)
- ③ Ventilation number, expiratory time, the number of correct ventilation and total ventilation are displayed on the LED panel.

(4-1) Head tilt-Chin lift

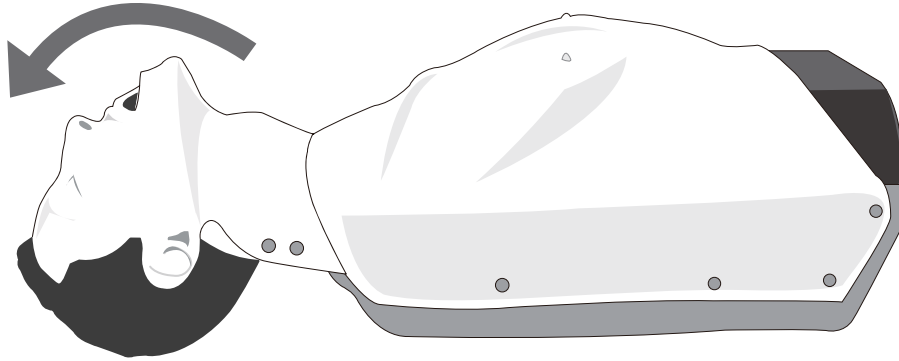

(4-2) Jaw thrust maneuver

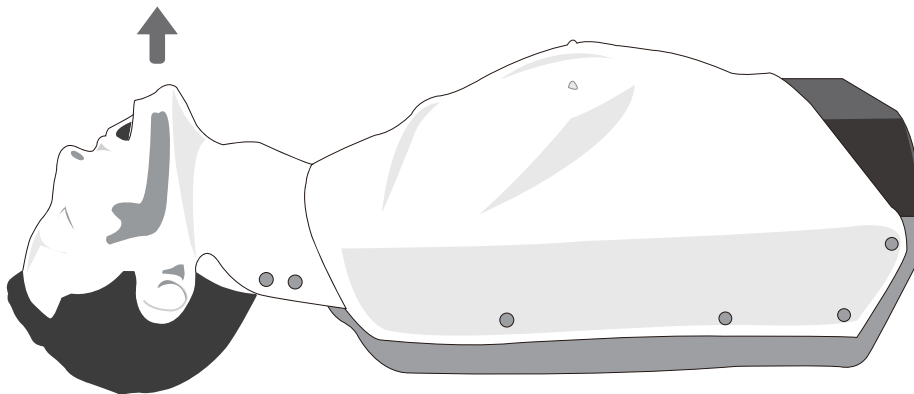

(4-3) Bag-valve-mask ventilation

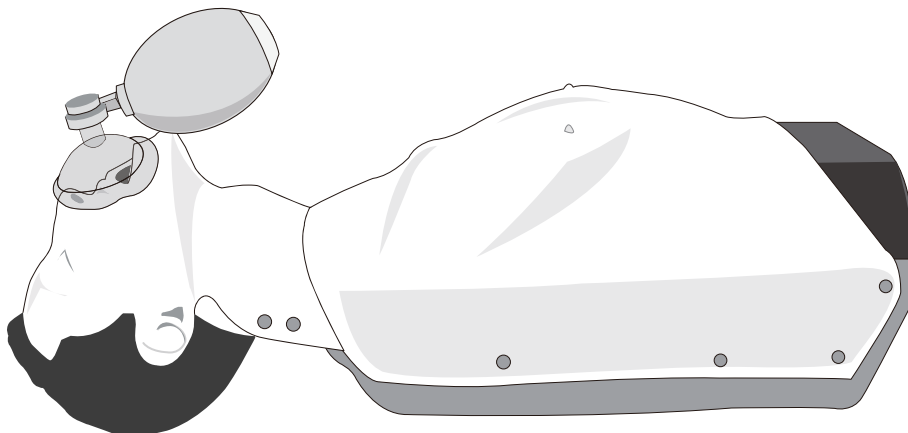

(4-4) Insert OPA/NPA

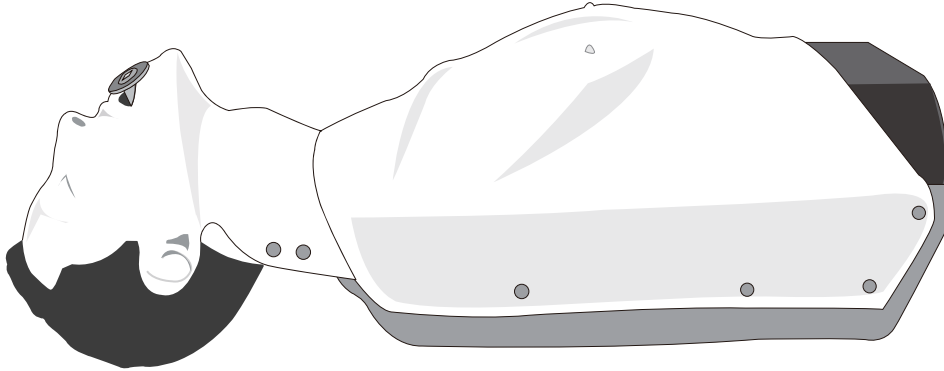

(4-5) Intubation with a laryngoscope

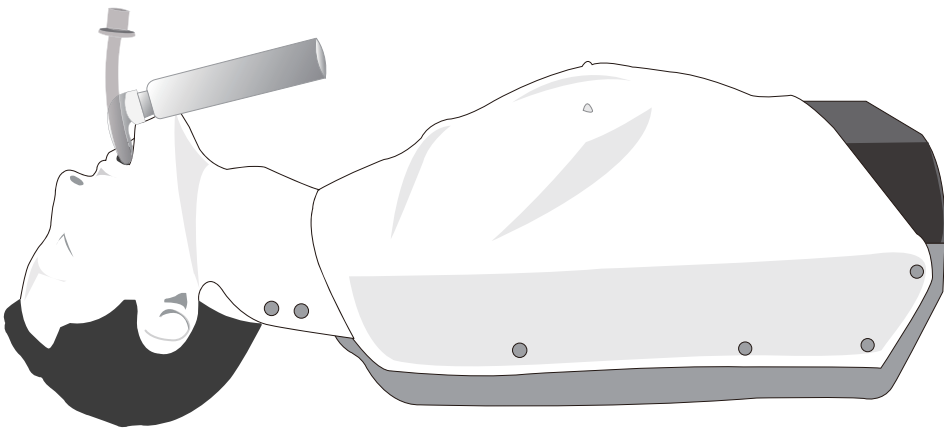

(4-6) Intubate ETT

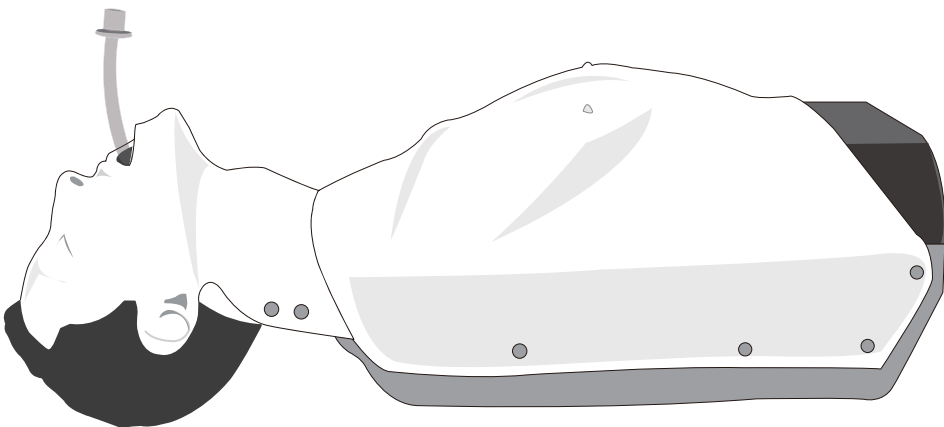

(4-7) Intubate I-gel

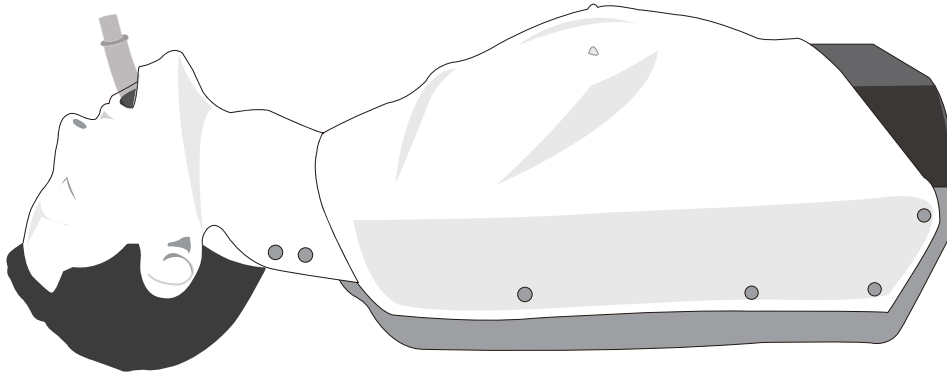

(4-8) Observable chest rising during ventilation

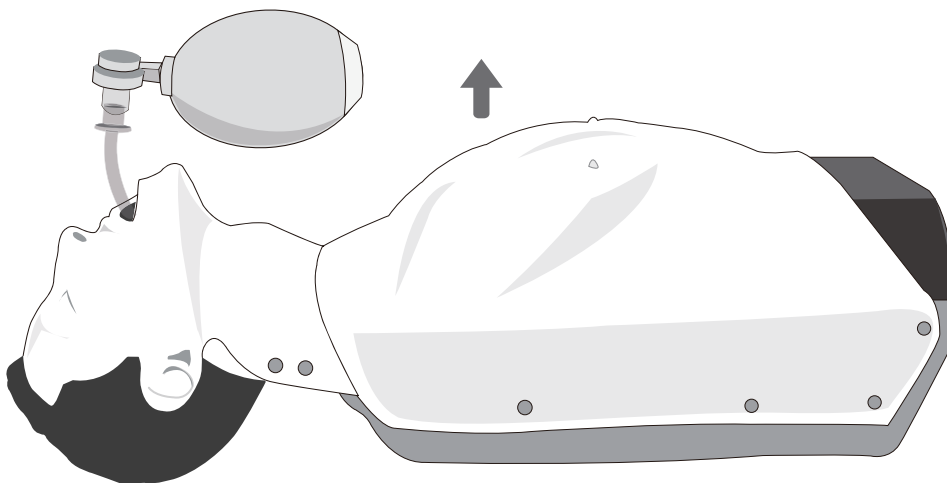

(4-9) Click sound for the front teeth while an excessive use of laryngoscope

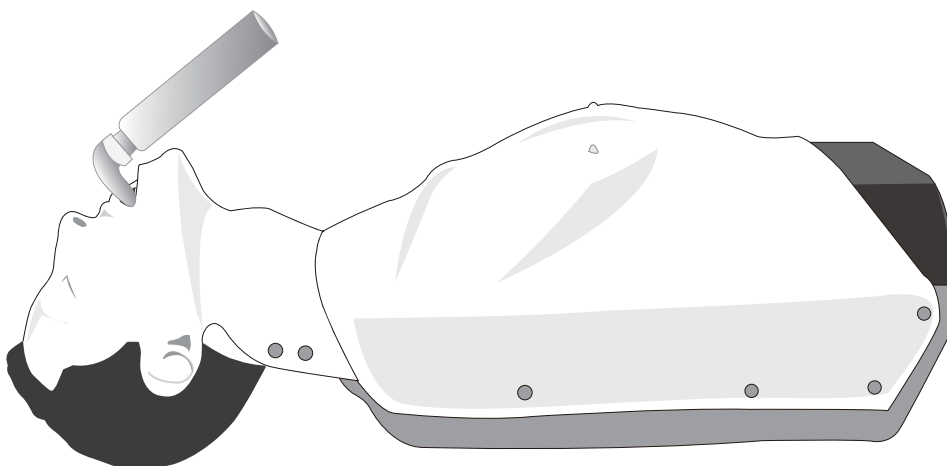

(5) Layout of LED panel

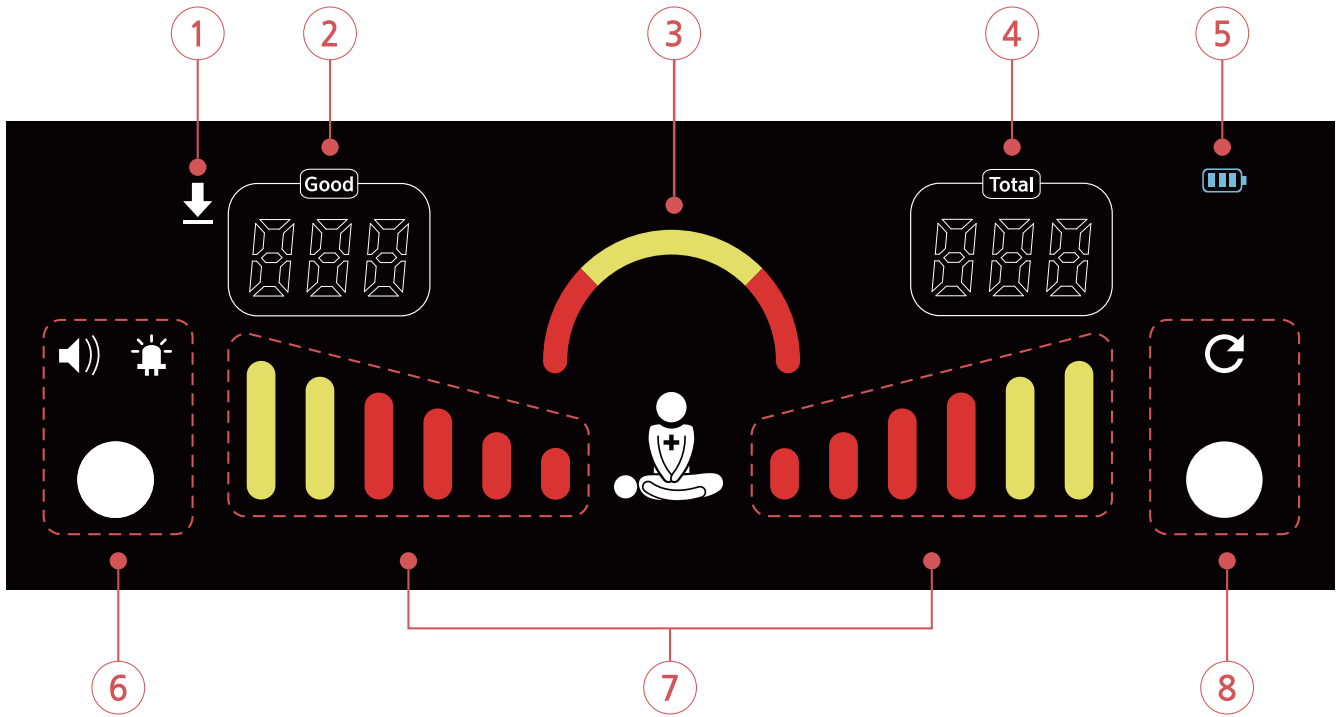

- ① LED Displaying Chest Compression ON / LED Displaying Ventilation OFF
- ② Number of Good chest compression / Hand location / Compression depth / Number of Good ventilation / Ventilation volume / Hand location in real-time, Compression depth, Displaying the number of good compression after training Ventilation volume in real-time, Displaying the number of ventilation after training
When there is no input, the number of good compression and the number of ventilation is being displayed repeatedly
- ③ Displaying Compression rate / Expiratory time during ventilation in 3 stages
- ④ Total compression number / Ventilation number
- ⑤ Battery status
- ⑥ Option button in 4 stages (repeated)

Sortation	Stage 1	Stage 2	Stage 3	Stage 4
Sound	ON	OFF	OFF	ON
LED	ON	OFF	ON	OFF

- ⑦ Compression Depth / Incomplete recoil / Volume of ventilation
- ⑧ Reset button

- Battery saver mode will be automatically turned on and the LED panel will stop displaying when chest compressions are not detected for 60 minutes. Press the Ⓢ or Ⓢ button to begin again.

(6) Compression Depth / Ventilation volume

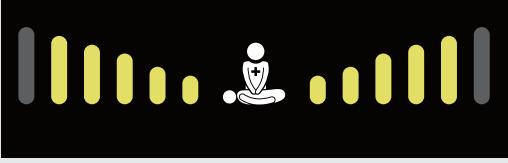
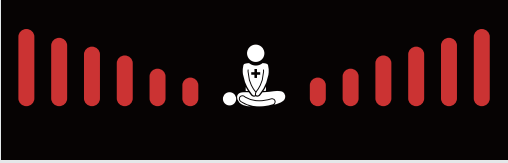
LED	Compression Depth	Ventilation Volume
	Insufficient	Insufficient
	Correct	Correct
	Over-compression	Excessive

(7) Compression Rate / Expiratory Time

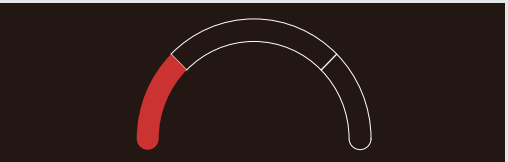
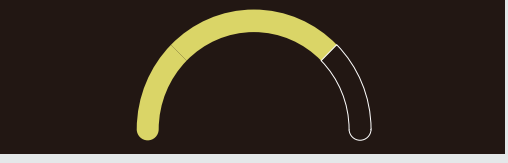
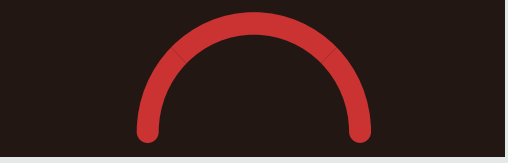
LED	Compression Depth	Expiratory Time
	Slow	Slow
	Correct	Correct
	Fast	Fast

(8) Display layout

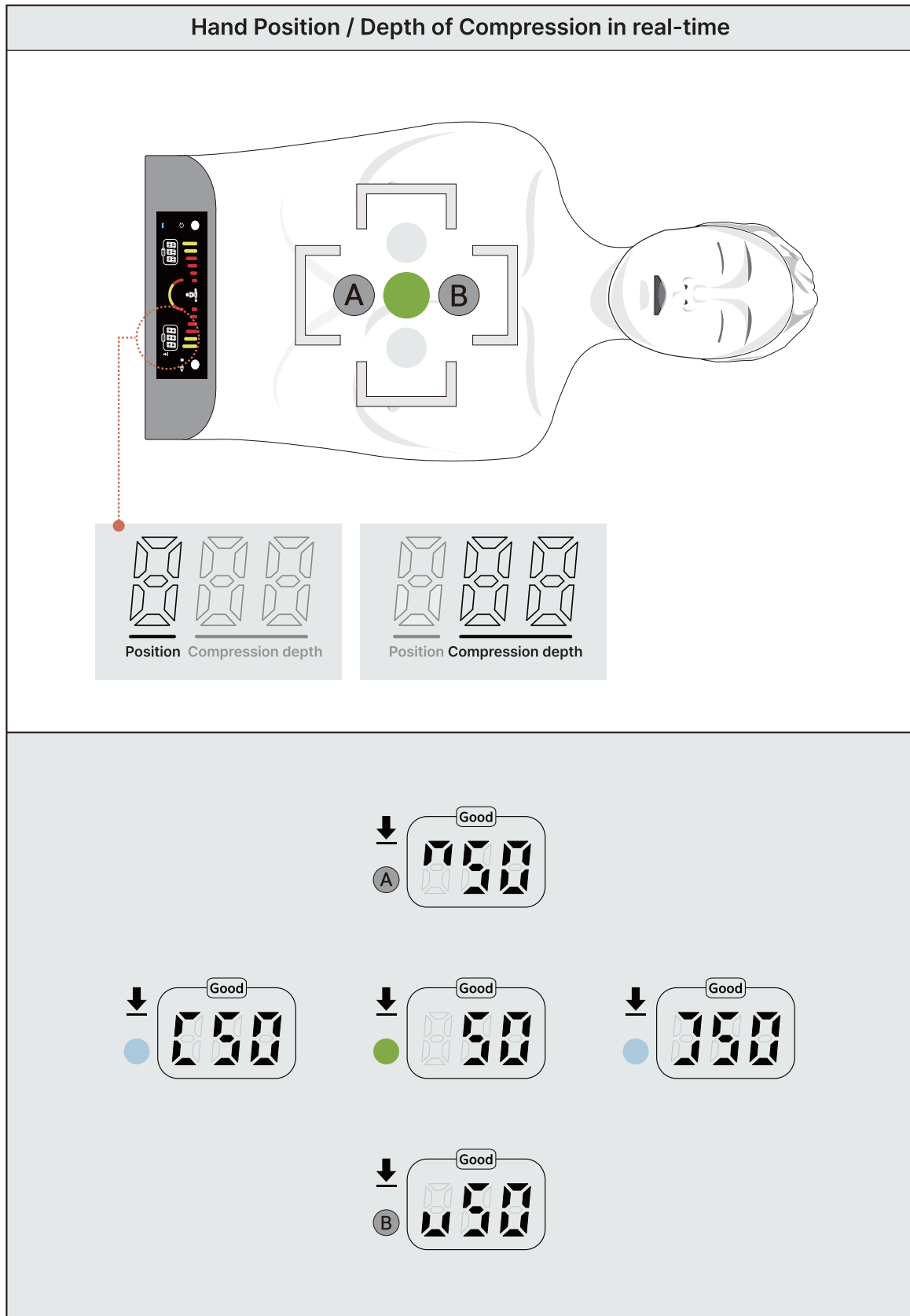

Cleaning and Storage

(1) How to clean and sanitize CPR manikin

- For mouth-to-mouth ventilation, it is recommended to use a bag-valve mask (BVM), pocket mask, or face shield to maintain hygienic conditions.
- The airway parts consist of the face skin, check valve, and the lung bag.
- If there is a risk of infection during ventilation training, it is recommended to clean the face skin by following the guideline and to use the check valve module and lung bag for single use only.
- Face shield : Clean with the 70~83% ethanol or a mild detergent. Ensure it is thoroughly cleaned and dried before use.70%~83% Ethanol
- Clean and disinfect the plastic parts where air flows back from the lung bag to outside through the check valve module, using alcohol swabs or a soft cloth soaked in ethanol.
- Clean the skin and plastic parts excluding the airway parts by following the guideline at below.
 - ① Wipe off stains using a moist cloth.
 - ② For additional cleaning, apply a recommended amount of solvent to a cloth or use alcohol swabs and wipe the manikin.
 - ③ Dry the surface with a clean, dry cloth.

Recommended solvents

- 70~83% Ethanol
- 70% Isopropyl Alcohol
 - Isopropyl alcohol is NOT recommended for plastic parts.

(2) When using a BVM or Pocket Mask

- When using a BVM, it is recommended to sanitize or replace the airway parts once a month.
- When using a pocket mask equipped with a one-way valve, it is recommended to sanitize or replace the airway parts once a week.
- Face shield : Clean with the 70~83% ethanol or a mild detergent. Ensure it is thoroughly cleaned and dried before use.
- Check Valve Module : Clean the inside with the 70~83% ethanol or a mild detergent, dry thoroughly, and ensure the valve is functioning properly before reuse.
- The lung bag is consumable. Replace it based on the moisture inside or storage conditions.

(3) When using a Face shield

- If there is a risk of infection while using a face shield, it is recommended to use the check valve module and lung bag for single use only.
- Face shield : Clean with the 70~83% ethanol or a mild detergent. Ensure it is thoroughly cleaned and dried before use.
- Check valve module is disposable. Please replace it after a single-use or clean, dry and reuse it by following the guideline at below after a use.
- Check Valve Module : Clean the inside with the 70~83% ethanol or a mild detergent, dry thoroughly, and ensure the valve is functioning properly before reuse.
- Lung bag is disposable. Replace it depending on the moisture or storage conditions.

* Cleaning and replacement cycles may vary depending on the usage environment.

(4) Change the lung airbag

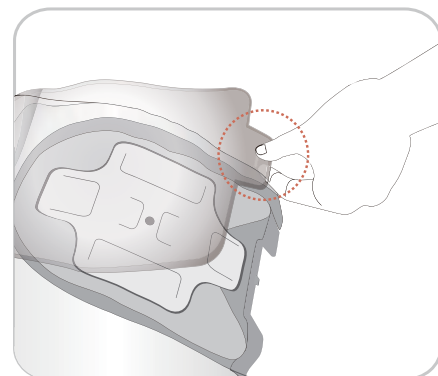
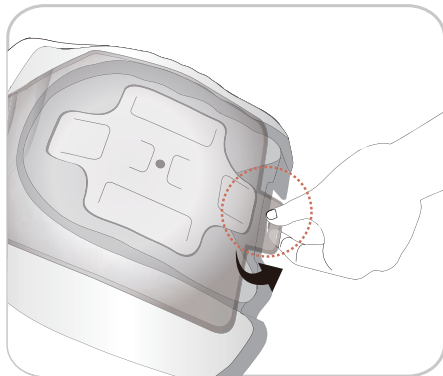
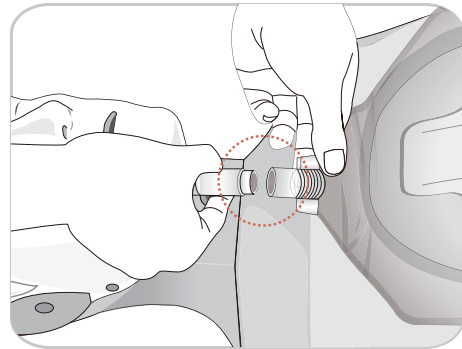
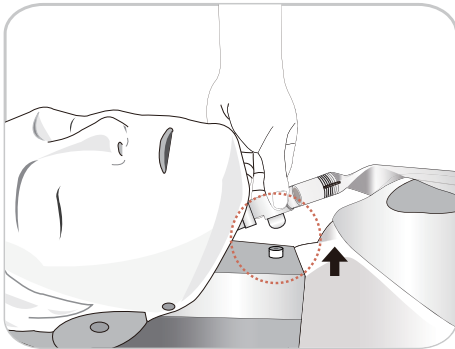
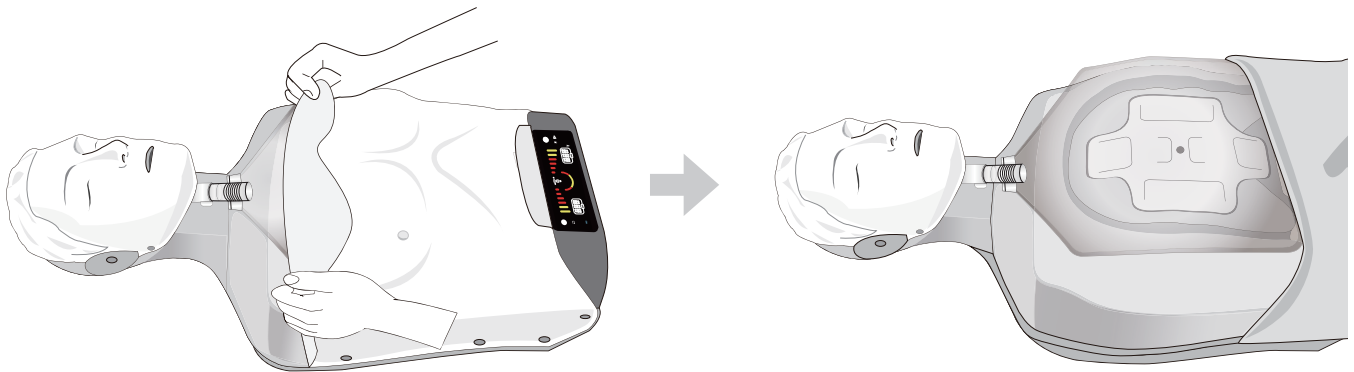

- ① Separate the chest skin from the manikin up to the abdomen.
- ② Disconnect the connector of the lung bag connected to the face of the manikin to disconnect it.
- ③ Unhook the lower part of lung bag from the chest plate of manikin, take the lung out.

- When connecting the lung bag, install it in reverse order.

Software

(1) Bluetooth Connection

- ① Turn on manikin and tablet PC.
- ② Select  Sherpa X application.

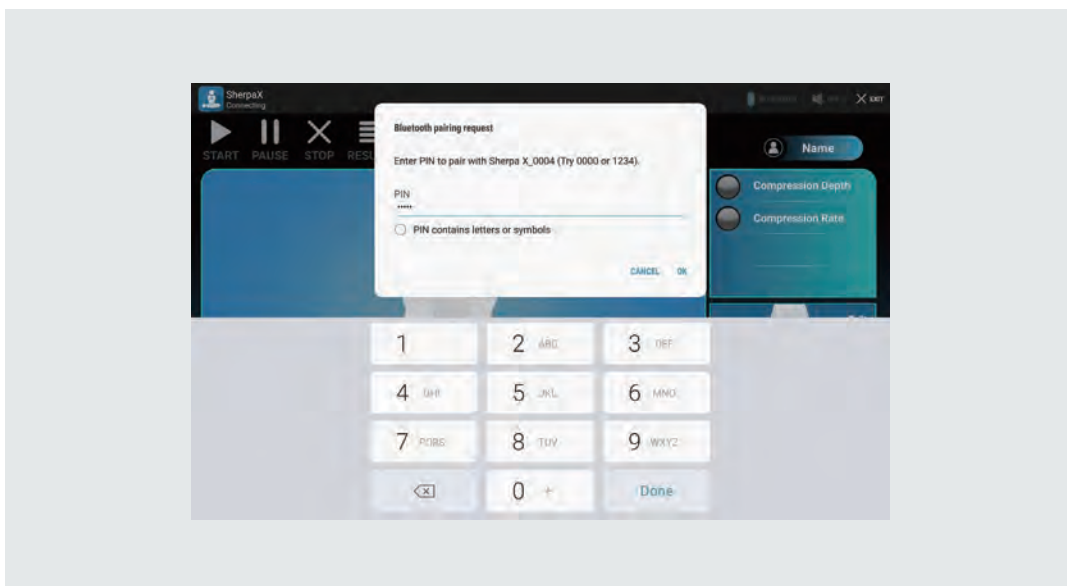
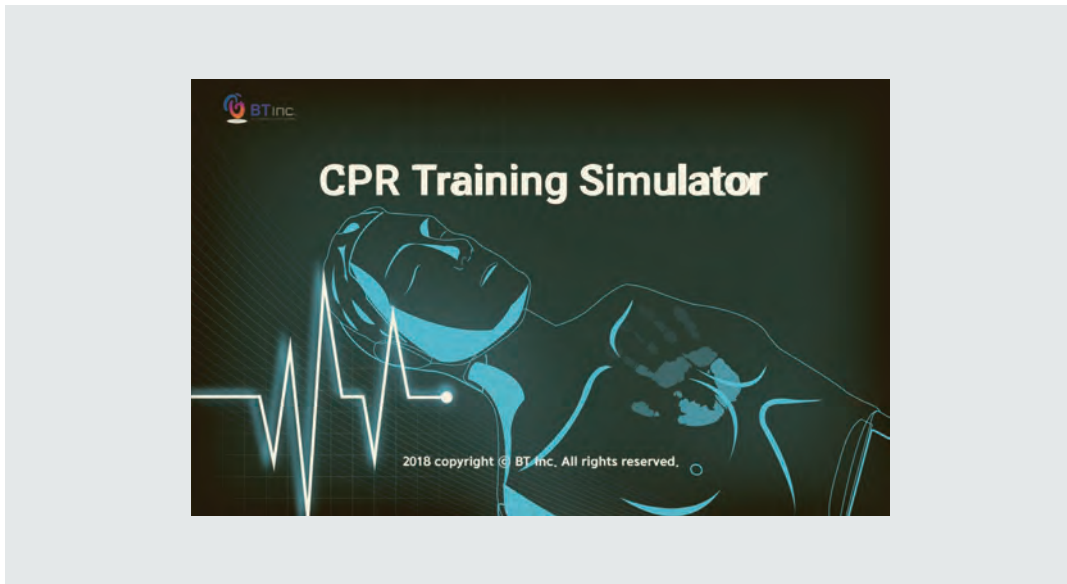

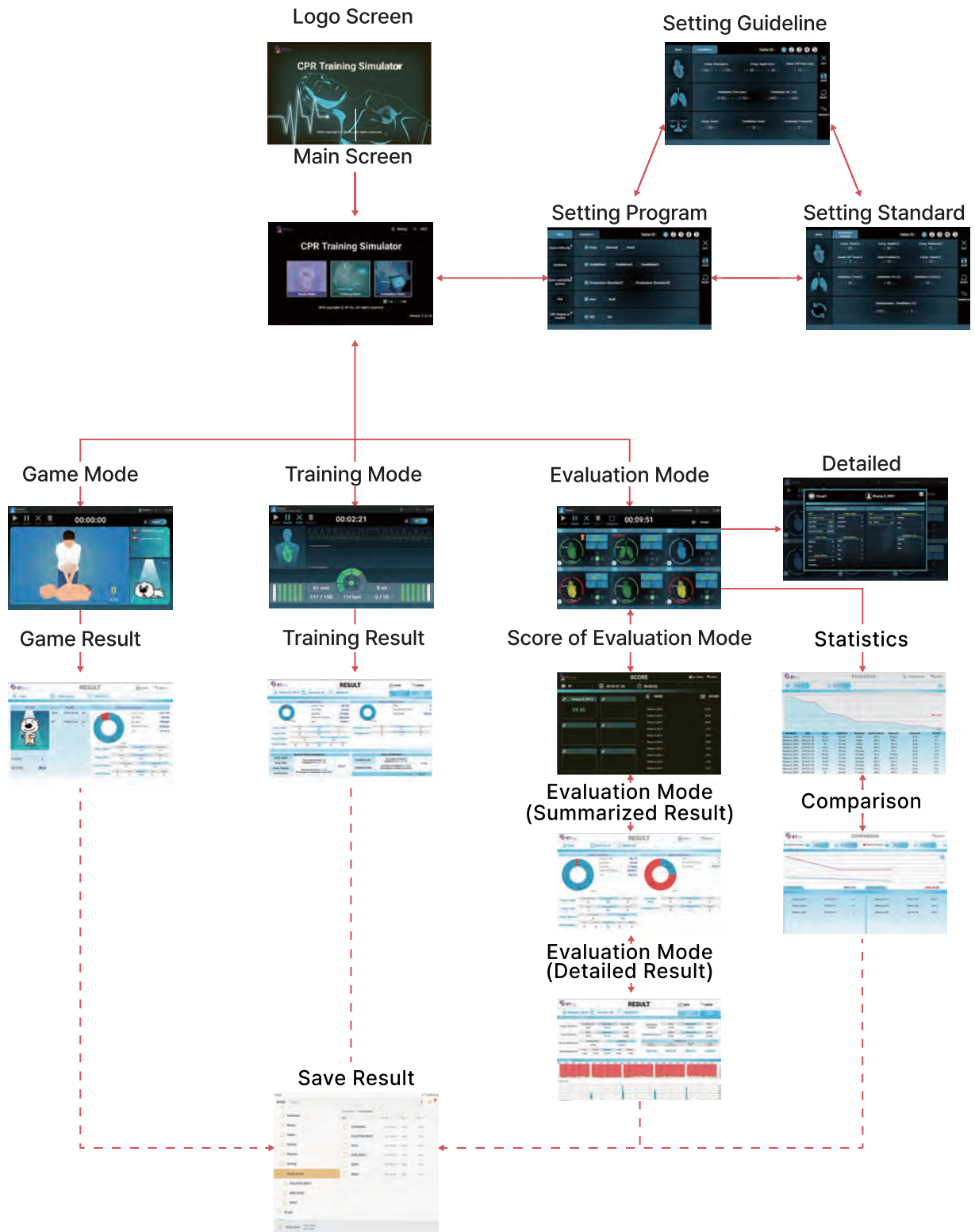

- ③ A Bluetooth pop-up screen will appear, Enter the pin code.
(PIN Code : 56789)
 - ④ Once connected, it will automatically connect next time.
 - ⑤ When it is now automatically connected, Pair Bluetooth by selecting Bluetooth icon.
- Bluetooth connection may be limited depend on the tablet
 - Please use a recommended tablet by BT.

(2) Layout

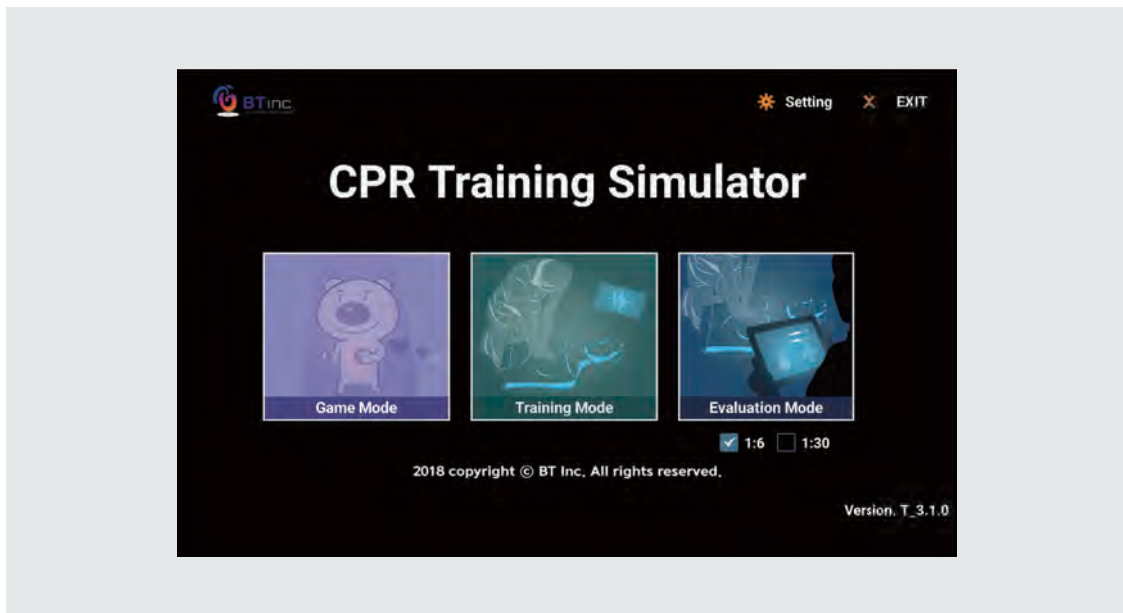

(3) Main Screen



- Start training by selecting a mode among 'Game mode', 'Training mode' and 'Evaluation Mode'.
- In evaluation mode, you can select between '1:6 mode' and '1:30 mode'.
In '1:6 mode', Sherpa X software is going to evaluate the training on its own.
In '1:30 mode', the evaluation is linked with Sherpa-XM software.
*** Refer to Sherpa-XM user guide for more information of 1:30 Mode.**
- Guideline and scoring can be modified at '  setting'.
- Select the desired number of devices when beginning 'Evaluation Mode'.
- When '  Stop' is selected, the training will be finished.

(4-1) Setting Program

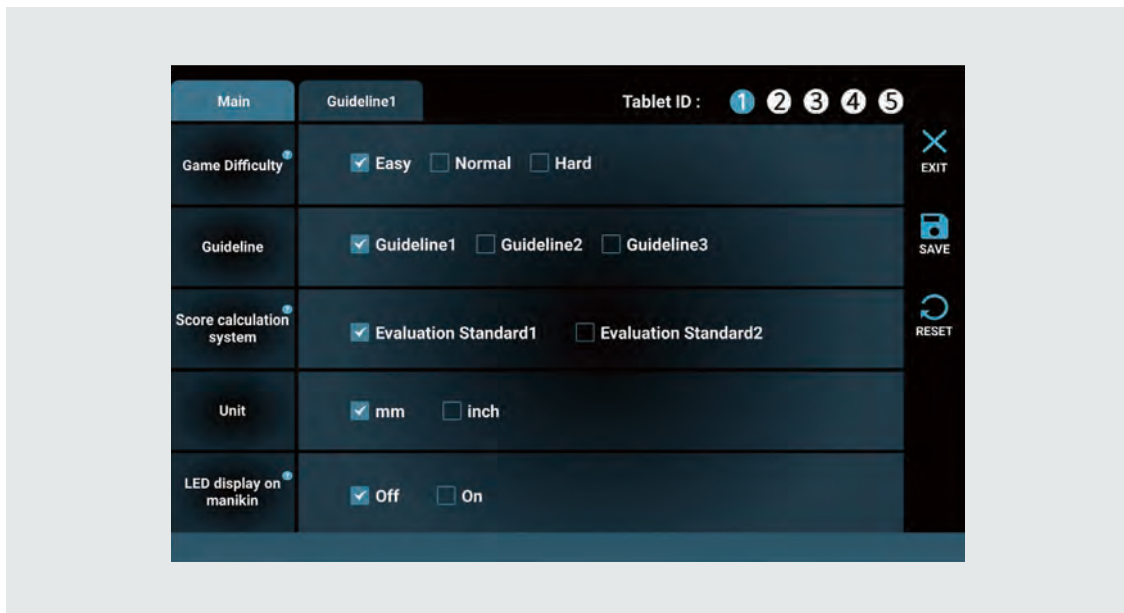

- When using '1:30 mode' for evaluation, you can number each tablet for a recognition.
* Refer to Sherpa-XM user guide for more information.
- At game mode, the level of difficulty can be chosen 'Easy', 'Normal', 'Hard'.
- The pre-set guideline can be applied to the training.
- The score calculation system can be chosen between Evaluation criteria 1 and 2.
- Inch and mm is offered for a default unit for compression depth.
- The display on the manikin can be ON/OFF.(At game mode, the display is off.)

(4-2) Setting Guideline



- Guideline can be modified easily according to the curriculum.
- Compression rate, Compression depth, Hands-off time.
- Ventilation time, Ventilation volume.
- Compression count, Ventilation count, Evaluation time.

Icon	Description
	Exit : Exit from "setting"
	Save : Save the Setting value
	Reset : Reset the Setting value
	Guideline : Setting Guideline regarding chest compression and ventilation
	Evaluation Setting : Evaluation Setting regarding chest compression and ventilation

(4-1) Standard 1

<Score calculated according to the score ratio of each list>



- Scoring can be set according to evaluation criteria.
- Set the evaluation ratio for Compression rate, Compression depth, Compression relaxation, Hands-off time, Hand position, Compression count.
- Set the evaluation ratio for Ventilation time, Ventilation volume, Ventilation count.
- Set the evaluation ratio for Ventilation : Chest compression.

(4-2) Standard 2

<Score calculated when all the lists are correct>



- You can select the wanted evaluation item from the list according to the curriculum.
- Compression depth, hand position, recoil, rate
- Ventilation time, volume
- Set the percentage of score for Compression : Ventilation

(5-1) Game Mode

- At game mode, trainee can perform self-training only for chest compression.

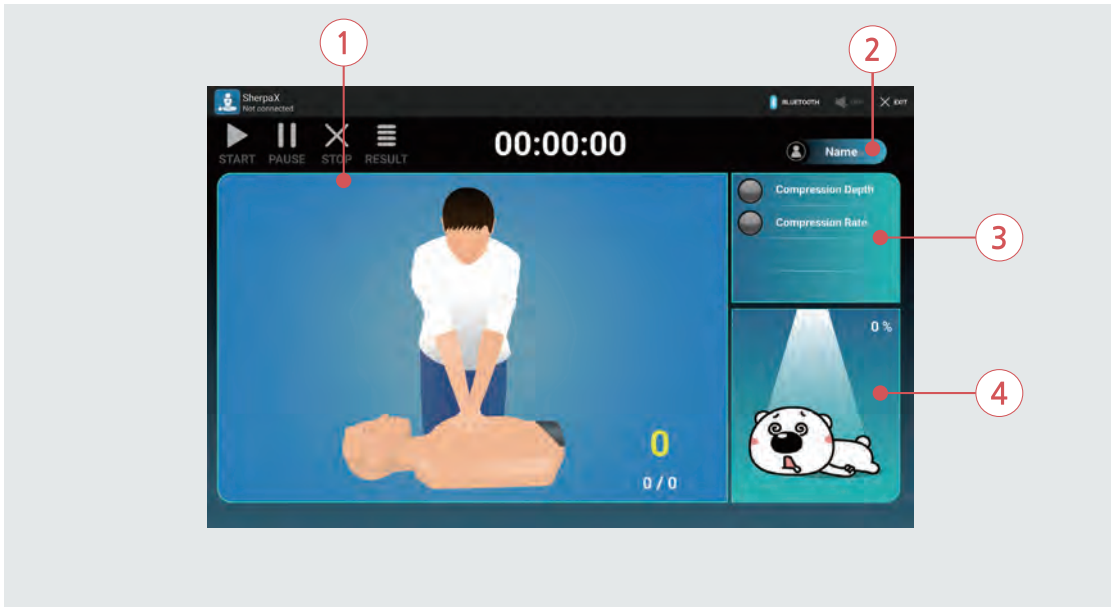

- ① The result for the chest compression is displayed in real-time.
(Touch the screen to change the image.)
- ② User name can be changed.
- ③ The compression depth, compression rate, hand position, compression relaxation is being monitoring according to the level of difficulty.
- ④ The animation is changed according to the trainee's performance.
(Touch the screen to change the character.)



Icon	Description
	Bluetooth : Setting Bluetooth
	Start / Stop / Pause : Start training / Stop training / Pause training
	Result : Check the result after training
	Trainee name : Insert the Trainee name
	Metronome : 100bpm / 110bpm / 120bpm / GOOD (Good Compression) / OFF
	Stop : Go to main screen

(5-2) Game Mode-Result

- Result data can be checked and saved at 'Result' after training.
- The result file is saved in JPEG format.



① The ranking in game mode can be reset.

Icon	Description
	Calendar : Displaying the training date
	Clock : Total training time

(6-1) Training Mode

- Trainees can practice by themselves in training mode.

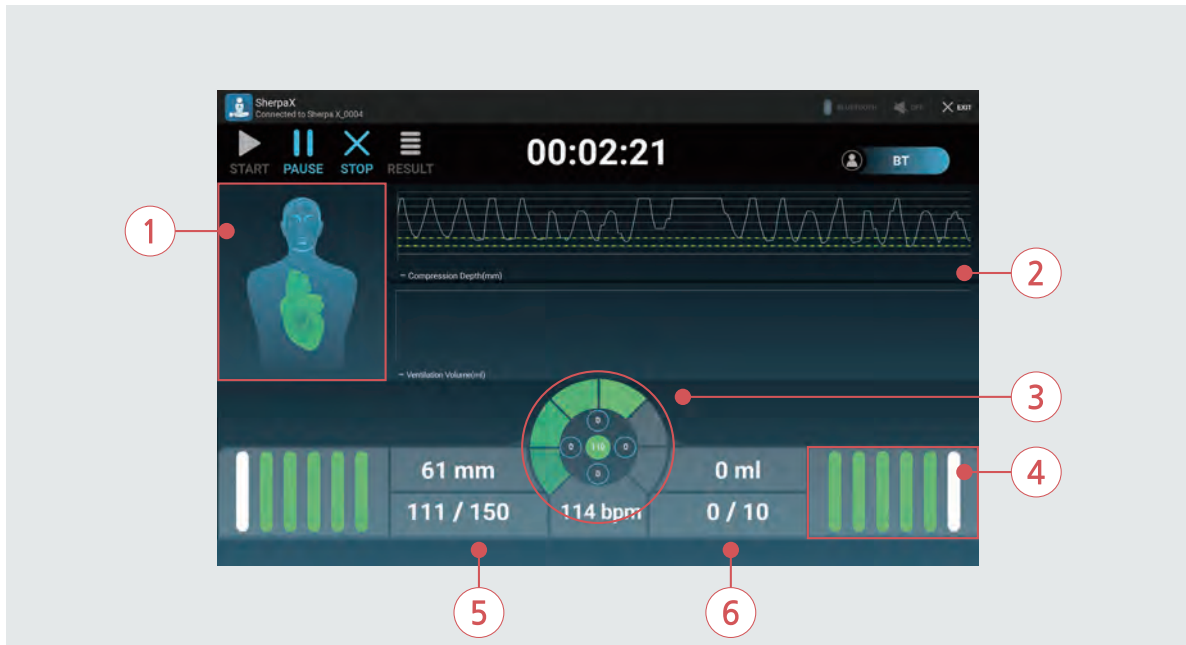

- ① The heart and lung are displayed during chest compression and ventilation and the color will be changed according to the result. Green(Good), Red(Not-good)
- ② Compression depth / ventilation volume is displayed in real-time.
- ③ Hand position / Compression count / Compression rate / Ventilation time is shown in 3 stages.
- ④ Compression depth, Incomplete Compression relaxation, Ventilation volume is displayed.
- ⑤ The number of chest compression and compression depth are displayed in real-time.
- ⑥ The number of ventilation and ventilation volume are displayed in real-time.

(6-2) Training Mode-Result





- Result data can be checked and saved at 'Result' after training.
- The result file is saved in JPEG format.

(7-1) Evaluation mode

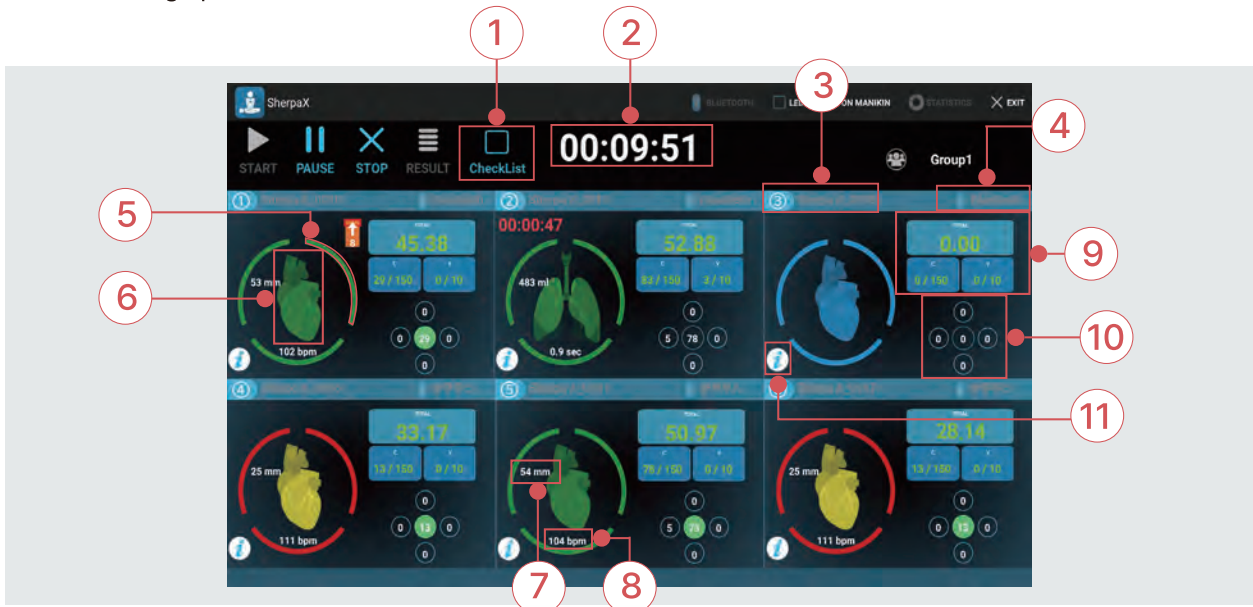
- Evaluation mode is to evaluate the trainee by trainer and it offers a group training by connecting up to 6 manikins.



- ① Check the performed skills from the checklist.
- ② Practice time is being displayed according to the set time limit.
- ③ Change the trainee name.
- ④ Connect or disconnect the Bluetooth connection.
- ⑤ It displays the compression rate during chest compression and ventilation rate during ventilation.
Compression rate : Green(Good), Yellow(Slow), Red(Fast)
Ventilation rate : Green(Good), Yellow(Slow), Red(Fast)
- ⑥ It displays the compression depth during chest compression and ventilation volume during ventilation.
Compression depth : Green(Good), Yellow(Not enough), Red(Over compression)
Ventilation volume : Green(Good), Yellow(Not enough), Red(Too much)
- ⑦ It displays the compression depth during chest compression and ventilation volume during ventilation in number.
- ⑧ It displays the compression rate during chest compression and ventilation rate during ventilation in number.
- ⑨ It shows the number of compression and ventilation and also the evaluation score in real time.
- ⑩ It displays the hand location; it is green in the good location and it is red for the rest.
- ⑪ Check the real-time data for each individual.

Icon	Description
	Group : Name the group.
	Statistics : Switch the screen to the statistics.
	Detailed screen : Switch the screen to the detailed screen.

(7-2) Evaluation Mode-Detailed screen

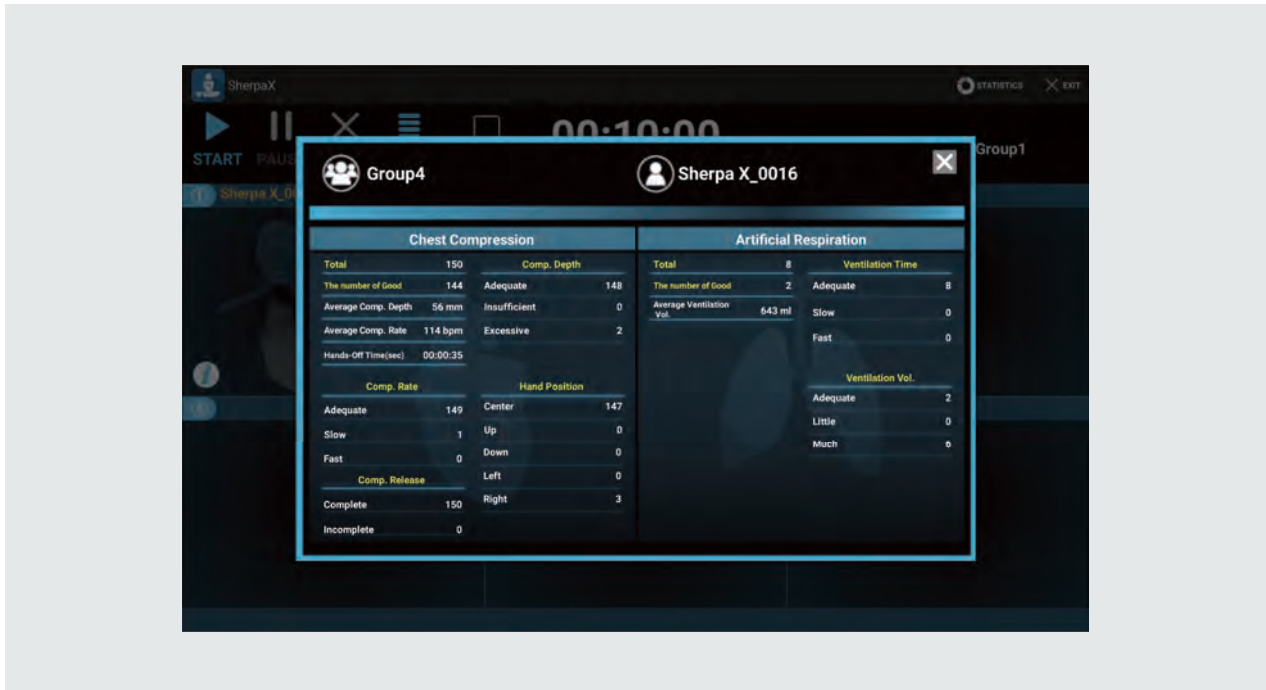

- Data regarding chest compression and ventilation can be checked in real time.

(7-3) Evaluation Mode-Score

- After the training, the rank and the score of the trainee will be displayed at 'Score and ranking'.

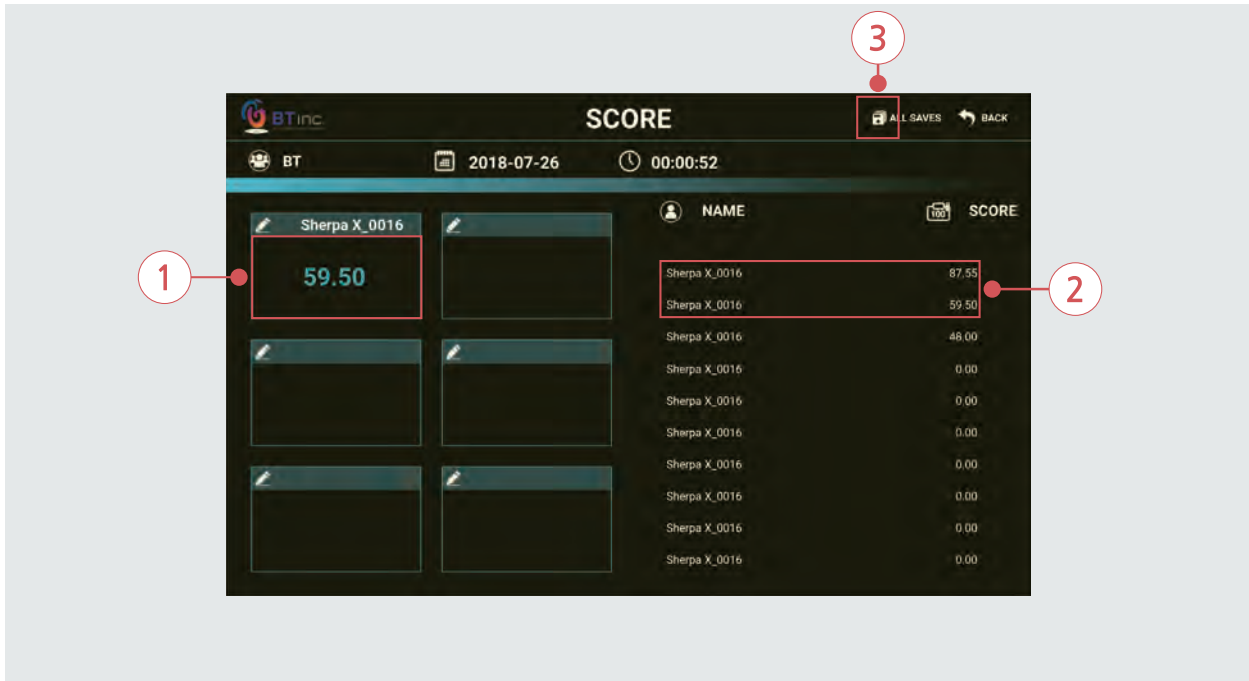

- ① Go to the individual training result by selecting the score of each trainee.
- ② The results will be listed automatically according to the score.
(Please long tap the trainee's name to delete the related training data.)
- ③ Save the all results of trainees.

(7-4) Evaluation Mode-Summarized result(Evaluation criteria 1)

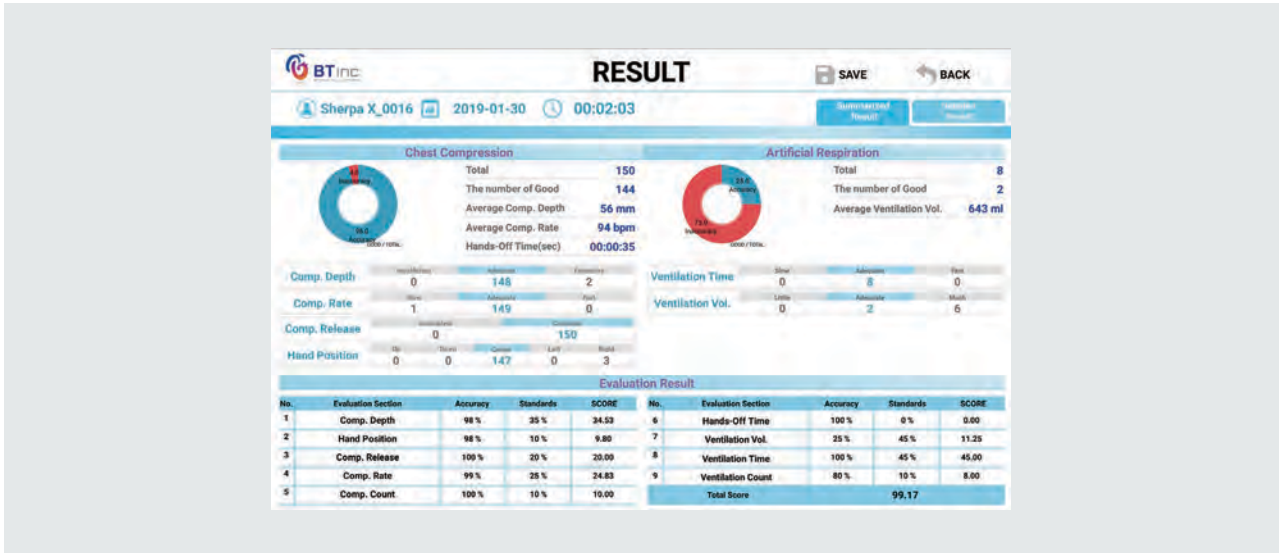

- After training the detailed result can be checked and saved at 'Result'.
- The result file is saved in JPEG format.

(7-5) Evaluation Mode-Summarized result(Evaluation criteria 2)

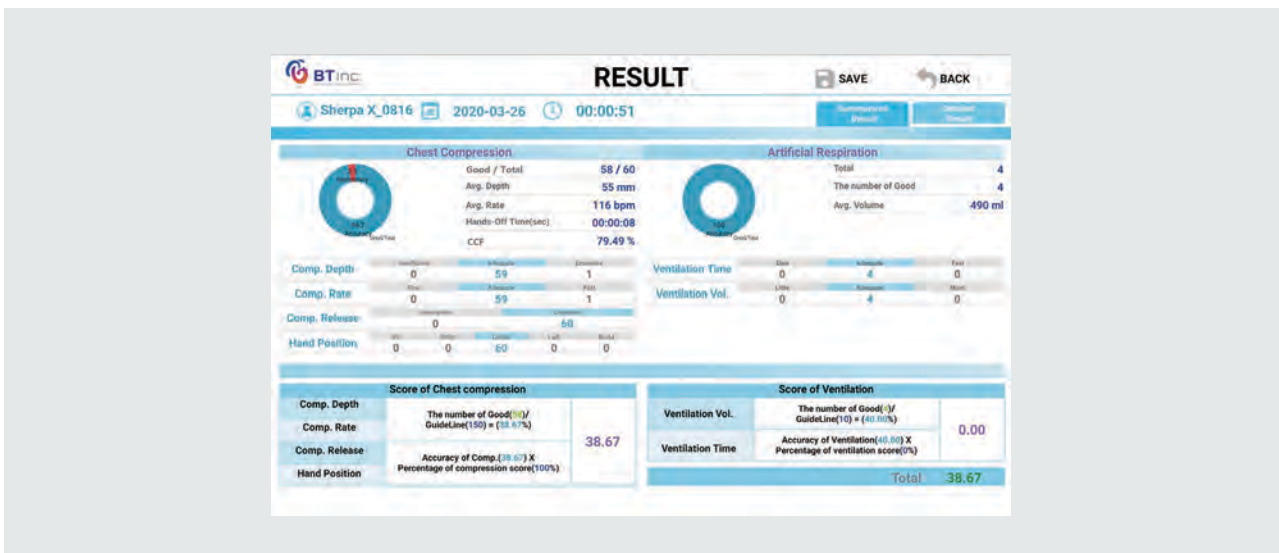

- After training the detailed result can be checked and saved at 'Result'.
- The result file is saved in JPEG format.

(7-6) Evaluation Mode-Detailed result

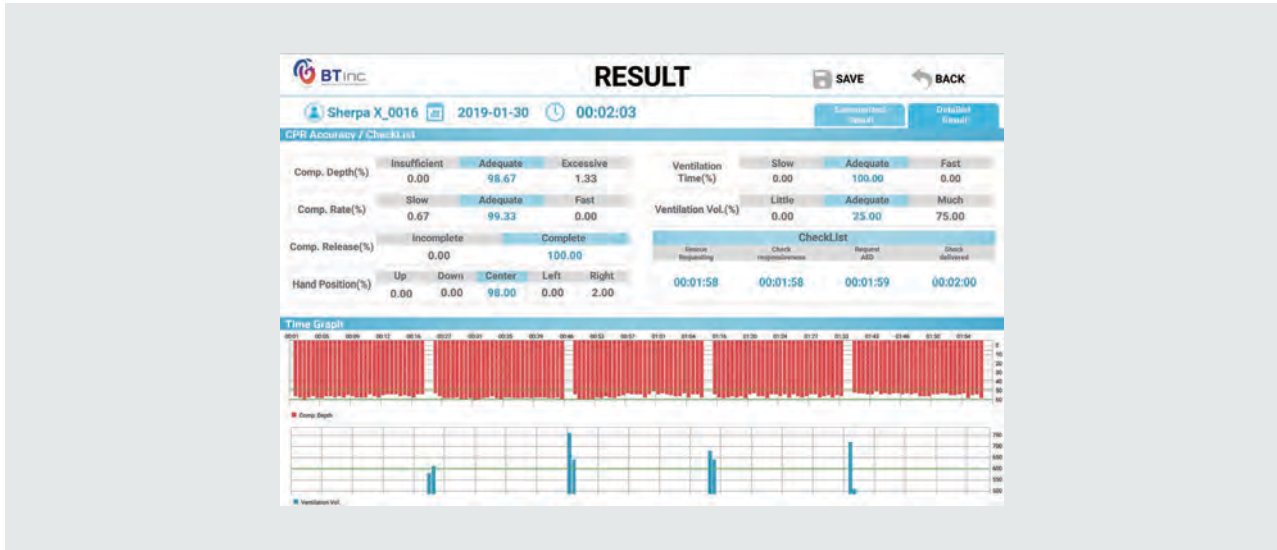



- After training the detailed result can be checked and saved at 'Result'.
- The result file is saved in JPEG format.

(8) Statistics

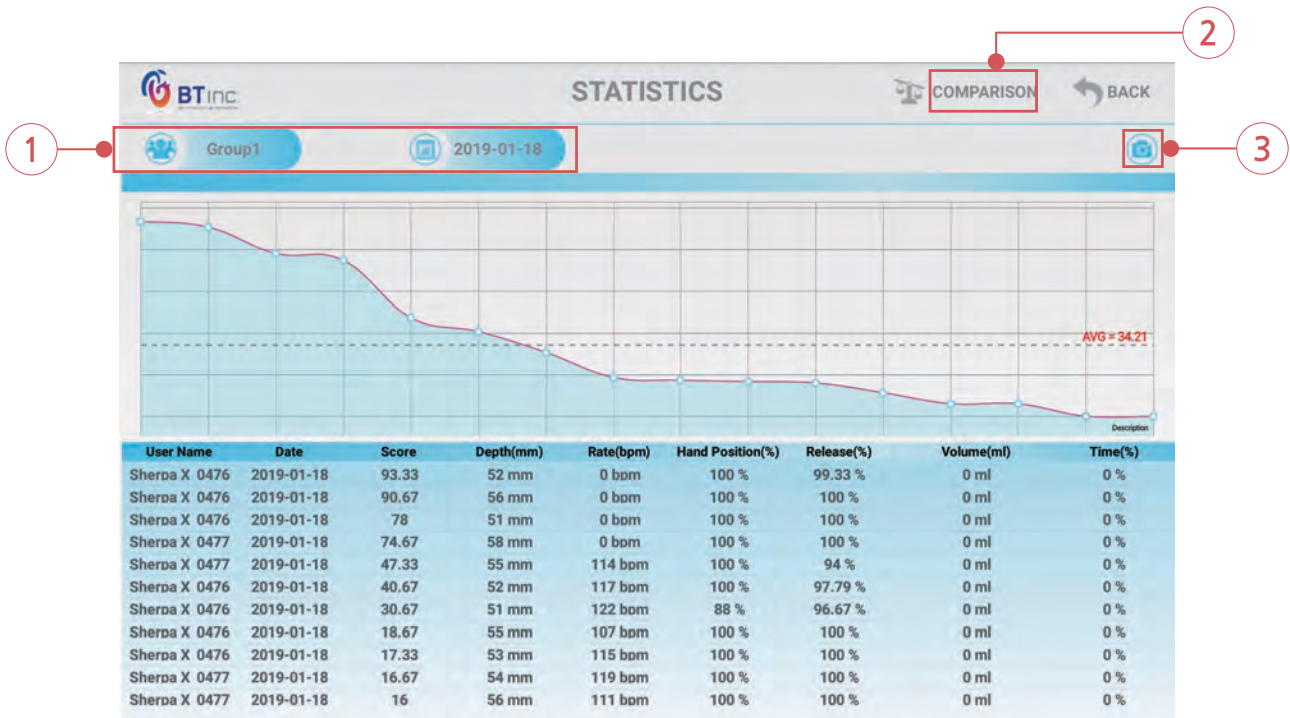
- Check the statistics of many results are save the excel and comparison graph.



- ① Select the group name and the date of training.
- ② 2 results can be compared by switching the screen to the comparison function.
- ③ Save the statistics graph.

Icon	Description
	Screenshot : Make a screenshot and save it.
	Comparison : Switch the screen to the comparison function.

(8) Comparison

- Select 2 targets for comparison, the data can be compared as graphs and saved.

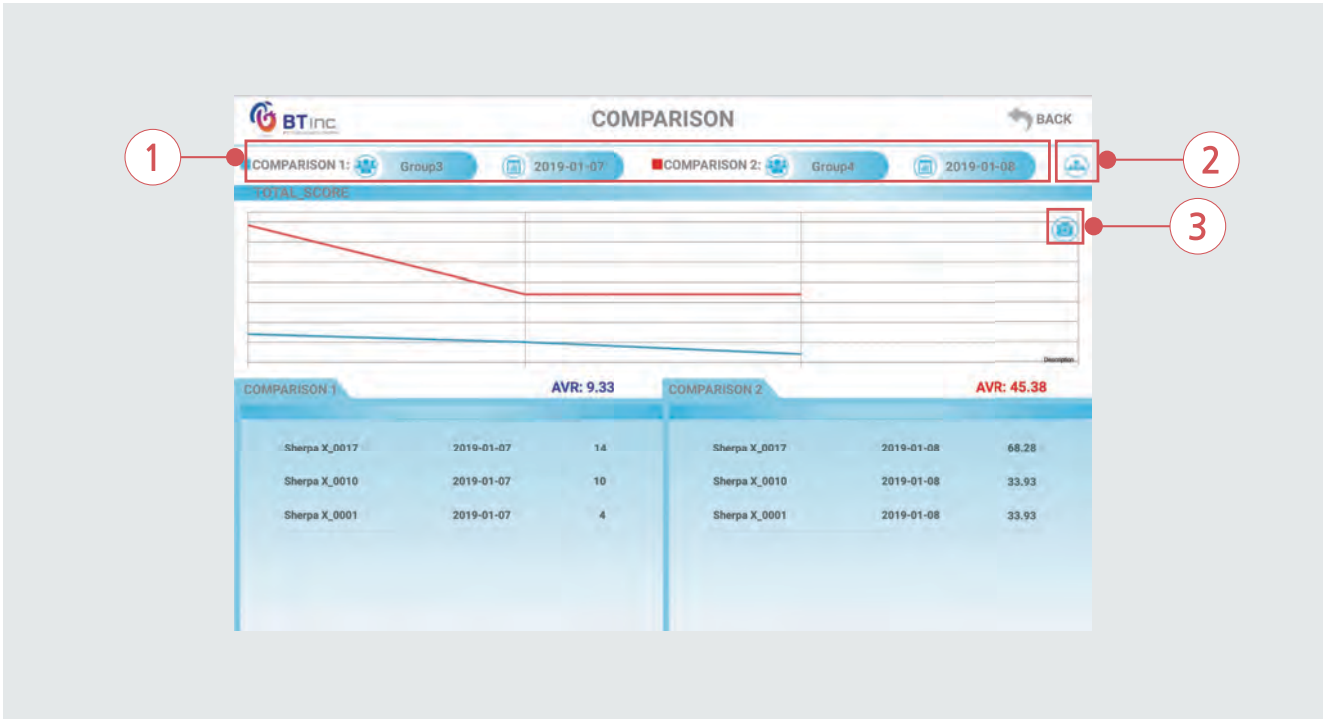

- ① Select 2 targets by selecting the group name and the date of training.
- ② Select the item and compare the training results.
- ③ Save the comparison graph

Icon	Description
	Search : Search the items which needed to be compared

(9) Folder for saved results

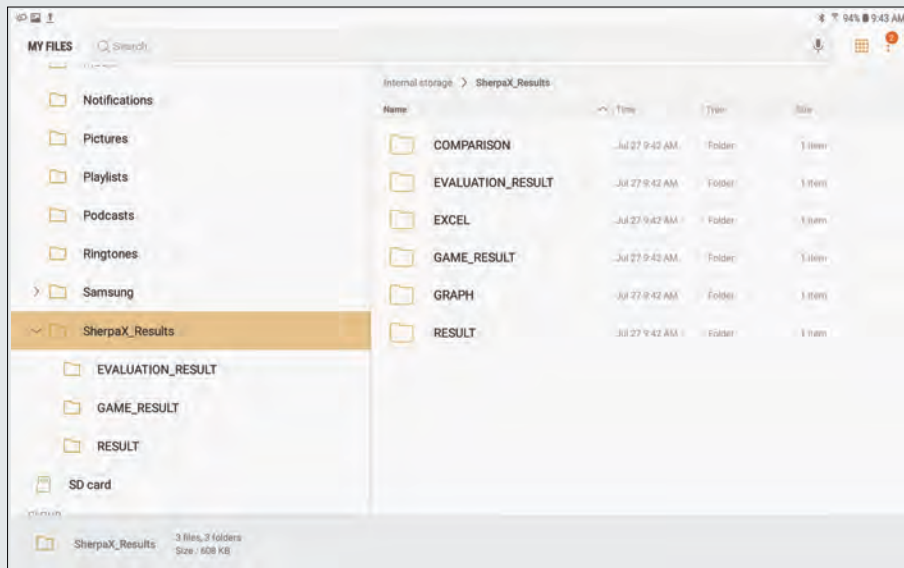

- If the Android version is lower than 10, please check the result at "Tablet PC > My Files > Internal Storage > Sherpa X_Results".

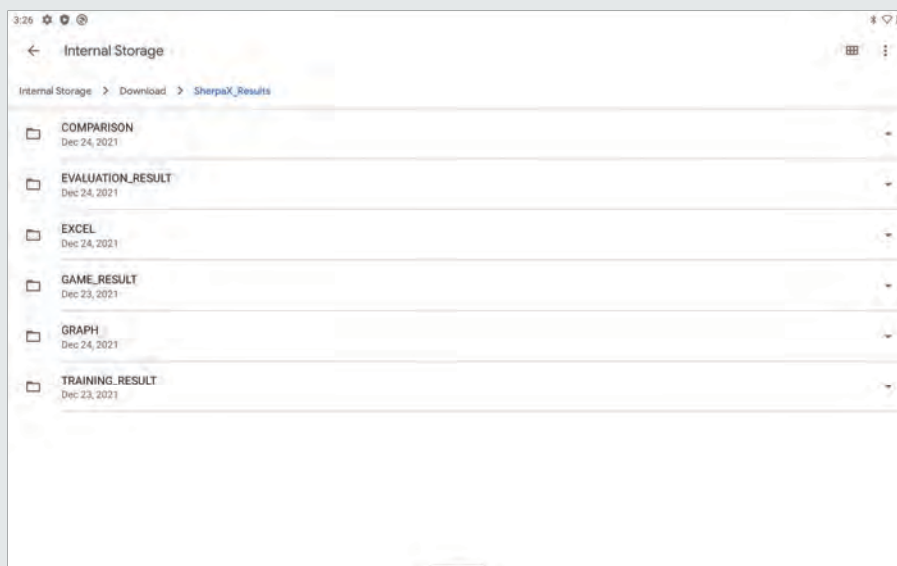

- If the Android version is greater than or equal to 10, please check the result at "Tablet PC > My Files > Internal Storage > Download > Sherpa X_Results".

BT-SEEM-Air

CPR&Airway Management Training Model

A-313, Samsung Techno-valley, 140, Tongil-ro
Deogyang-gu, Goyang-si, Gyeonggi-do, 10594, Republic of Korea

Homepage: www.btinc.co.kr / E-mail: bt@btinc.co.kr
Tel: +82-2-2038-2903, +82-51-903-1144 / Fax: +82 303-3130-0607

Copyright(c) BT Inc. All rights reserved.